

# ***PIXMA iP5200***

# ***PIXMA iP5200R***

# **SERVICE**

# **MANUAL**

**Canon**

issue a revised edition.

The following do not apply if they do not conform to the laws and regulations of the region where the manual or product is used:

### **Trademarks**

Product and brand names appearing in this manual are registered trademarks or trademarks of the respective holders.

### **Copyright**

All rights reserved. No parts of this manual may be reproduced in any form or by any means or translated into another language without the written permission of Canon Inc., except in the case of internal business use.

Copyright © 2005 by Canon Inc.  
CANON INC.  
Inkjet Device Quality Assurance Div. 2  
451, Tsukagoshi 3-chome, Saiwai-ku, Kawasaki-shi, Kanagawa 212-8530, Japan



# I. MANUAL OUTLINE

This manual consists of the following three parts to provide information necessary to service the PIXMA iP5200:

**Part 1: Maintenance**

Information on maintenance and troubleshooting of the PIXMA iP5200

**Part 2: Technical Reference**

New technology and technical information such as FAQ's (Frequently Asked Questions) of the PIXMA iP5200

**Part 3: Appendix**

Block diagrams and pin layouts of the PIXMA iP5200

**Reference:**

This manual does not provide sufficient information for disassembly and reassembly procedures. Refer to the graphics in the separate Parts Catalog.



## II. TABLE OF CONTENTS

### Part 1: MAINTENANCE

#### [1. MAINTENANCE](#)

[1-1. Adjustment, Periodic Maintenance, Periodic Replacement Parts, and Replacement Consumables by Service Engineer](#)

[1-2. Customer Maintenance](#)

[1-3. Product Life](#)

[1-4. Special Tools](#)

[1-5. Serial Number Location](#)

#### [2. LIST OF ERROR DISPLAY / INDICATION](#)

[2-1. Operator Call Errors](#)

[2-2. Service Call Errors](#)

[2-3. Warnings](#)

[2-4. Troubleshooting by Symptom](#)

#### [3. REPAIR](#)

[3-1. Notes on Service Part Replacement \(and Disassembling / Reassembling\)](#)

[3-2. Special Notes on Repair Servicing](#)

[3-3. Adjustment / Settings](#)

[\(1\) Paper feed motor adjustment](#)

[\(2\) Grease application](#)

[\(3\) Waste ink counter setting](#)

[\(4\) User mode](#)

[\(5\) Service mode](#)

[Destination settings](#)

[LF correction](#)

[3-4. Verification Items](#)

[\(1\) Service test print](#)

[\(2\) EEPROM information print](#)

#### [4. PRINTER TRANSPORTATION](#)

### Part 2: TECHNICAL REFERENCE

[1. NEW TECHNOLOGIES](#)

[2. CLEANING MODE AND AMOUNT OF INK PURGED](#)

[3. PRINT MODE](#)

[4. FAQ \(Problems Specific to the iP5200 and Corrective Actions\)](#)

### Part 3: APPENDIX

[1. BLOCK DIAGRAM](#)

[2. CONNECTOR LOCATION AND PIN LAYOUT](#)

[2-1. Logic Board Ass'y](#)

[2-2. Carriage Board \(Print Head Connector\)](#)

[PIXMA iP5200 Specifications](#)

# *Part 1*

## **MAINTENANCE**



# 1. MAINTENANCE

## 1-1. Adjustment, Periodic Maintenance, Periodic Replacement Parts, and Replacement Consumables by Service Engineer

### (1) Adjustment

Adjustment	Timing	Purpose	Tool	Approx. time
Destination settings (EEPROM settings)	At logic board replacement	To set the destination.	None. Perform in the service mode.	1 min.
Waste ink counter resetting (EEPROM settings)	- At logic board replacement - At waste ink absorber replacement	To reset the waste ink counter.	None. Perform in the service mode.	1 min.
Paper feed motor position adjustment	At paper feed motor replacement	To adjust the belt tension. (Position the paper feed motor so that the belt is stretched tight.)	None.	5 min.
CD / DVD detection sensor light volume correction *1	- At logic board replacement - At carriage unit replacement	To correct the light volume for the CD / DVD detection sensor.	None. Perform in the service mode.	2 min.
Grease application	- At carriage unit replacement - At PR shaft ass'y replacement - At CL base / gear replacement	- To maintain sliding properties of the carriage shaft and the lift cam shaft. - To protect the printer's sliding portions (gears).	FLOIL KG-107A	1 min.
Ink system function check	- At logic board replacement - At platen unit replacement - At carriage unit replacement	To maintain detection functionality for presence of the ink tanks and each ink tank position.	None. Perform in the service mode.	1 min.
LF correction	- At feed roller replacement - At logic board replacement	To correct the line feed accuracy	None. Perform in the service mode.	3 min.

Note: DO NOT loosen the red screws at both ends of the carriage shaft, securing the print head position, as they are not re-adjustable.  
The red screws securing the paper feed motor may be loosened only at replacement of the paper feed motor unit.

\*1: Only for CD / DVD printing supported regions.

### (2) Periodic maintenance

No periodic maintenance is necessary.

### (3) Periodic replacement parts

There are no parts in this printer that require periodic replacement by a service engineer.

### (4) Replacement consumables

There are no consumables that require replacement by a service engineer.

## 1-2. Customer Maintenance

Adjustment	Timing	Purpose	Tool	Approx. time
Print head alignment	At print head replacement.	To ensure accurate dot placement.	- Printer buttons - Computer (automatic settings via the printer driver)	3 min.
Print head cleaning	When print quality is not satisfying.	To improve nozzle conditions.	- Printer buttons - Computer (settings via the printer driver)	1 min.
Print head deep cleaning	When print quality is not satisfying, and not improved by print head cleaning.	To improve nozzle conditions.	Computer (settings via the printer driver)	2 min.
Ink tank replacement	When an ink tank becomes empty. ("No ink error" via the computer, or ink tank LED flashing fast in red)	-----	-----	1 min.
Paper feed roller cleaning	When necessary	To clean the paper feed rollers.	Printer buttons	2 min.
CD / DVD print position adjustment	At CD / DVD printing, when necessary	To correct CD / DVD print position.	Computer (application software)	5 min.
Bottom plate cleaning	When the back side of the paper is smeared	To clean the platen ribs.	- Plain paper - Computer (settings via the printer driver)	1 min.
ASF sub-roller cleaning	When the paper fed from the ASF is smeared due to ink mist attached to the ASF sub-rollers.	To clean the ASF sub-rollers.	- Plain paper - Printer buttons <a href="#">[See Part 2, 4. FAQ, How to make and set the ASF sub-roller cleaning sheet, for details]</a>	1 min.

## 1-3. Product Life

### (1) Printer

Specified print volume (I) or the years of use (II), whichever comes first.

(I) Print volume : 18,000 pages

Black	1,500 character pattern	8,300 pages
-------	-------------------------	-------------

Color	A4, 7.5% duty per color pattern	5,400 pages
	A4, photo, borderless printing	400 pages
	4 x 6, photo, borderless printing	3,200 pages
	Postcard, photo, borderless printing	700 pages

(II) Years of use

5 years of use

**(2) Print head**

Print volume : 18,000 pages

Black	1,500 character pattern	8,300 pages
Color	A4, 7.5% duty per color pattern	5,400 pages
	A4, photo, borderless printing	400 pages
	4 x 6, photo, borderless printing	3,200 pages
	Postcard, photo, borderless printing	700 pages

**(3) Ink tank (target value)**

Pattern	Ink tank used	Print yield
Black text	PGI-5BK	Approx. 800 pages
Color chart	PGI-5BK	Approx. 1,250 pages
	CLI-8Y	Approx. 480 pages
	CLI-8M	Approx. 500 pages
	CLI-8C	Approx. 710 pages
Photo chart	CLI-8BK	Approx. 1,100 pages
	CLI-8Y	Approx. 280 pages
	CLI-8M	Approx. 250 pages
	CLI-8C	Approx. 390 pages

Black text: When printing the Canon standard pattern (1,500 characters per page) on A4 size plain paper, with the default settings in the Windows XP driver, using Word 2003.

Color chart: When printing the ISO/JIS-SCID N5 pattern on A4 size plain paper in bordered printing, with the default settings in the Windows XP driver, using Photoshop 7.0.

Photo chart: When printing the Canon standard pattern on 4" x 6" Photo Paper Plus Glossy in borderless printing, with the default settings in the Windows XP driver, using Windows XP Photo Printing Wizard.

The print yield in the table above is an average value measured in continuous printing, using the ink tank



immediately after it is unsealed, until the ink is out. Ink yield may vary depending on texts and photos printed, application software, print mode, and type of paper used.

#### 1-4. Special Tools

Name	Tool No.	Application	Remarks
Grease FLOIL KG-107A	QY9-0057-000	To be applied to the sliding portions of the carriage shaft and lift cam shaft.	In common with the S500 and S520.

#### 1-5. Serial Number Location

On the carriage flexible cable holder (visible on the right of the carriage after the printer is turned on, the access cover is opened, and the carriage moves to the center).



[To the top](#)

← <Part 1: 1. MAINTENANCE> →

## 2. LIST OF ERROR DISPLAY / INDICATION

Errors are indicated by the LED, and warnings are displayed on the monitor of the computer connected to the printer.

### 2-1. Operator Call Errors (by Alarm LED Blinking in Orange)

Alarm LED blinking in orange	Error [Error code]	Solution	Remarks
2 times	No paper. (ASF) [1000]	Set the paper in the ASF, and press the Resume/Cancel button.	
	No CD / DVD tray. [1001]* <sup>1</sup>	Set the CD / DVD tray, and press the Resume/Cancel button.	
	No paper in the cassette. [1003] (No paper in the front paper feed cassette.)	Set the paper in the cassette, and press the Resume/Cancel button.	
	No CD / DVD disc. [1002]* <sup>1</sup>	Set a CD or DVD in the CD / DVD tray (which is ejected at error occurrence), and insert the CD / DVD tray in the proper position. Then, press the Resume/Cancel button.	
3 times	Paper jam. [1300]	Remove the jammed paper, and press the Resume/Cancel button.	Error in paper feeding from the ASF.
	Paper jam in the rear guide. [1303]		Error in the duplex printing unit.
	Paper jam in the under guide. [1304]		Error in paper feeding from the cassette.
	Front door close error. [1250]	Open the paper output tray.	The error is indicated if the paper output tray is closed at start of a print job, or while a print job is being performed.
4 times	No ink. [1600]	Replace the empty ink tank(s), or press the Resume/Cancel button.	Pressing the Resume/Cancel button will exit the error without ink tank replacement, however, ink may run out during printing.
	Ink tank not installed. [1660]	Install the applicable ink tank(s) properly, and confirm that the LED's of all the ink tanks light red.	
5 times	The print head is not installed , or it is not properly installed.	Install the print head properly.	

	[1401] Print head temperature sensor error [1403]  Faulty EEPROM data of the print head [1405]		
6 times	Inner cover open. [1841] <sup>*2</sup>	Close the inner cover, and press the Resume/Cancel button.	
	Inner cover open during printing on paper. [1846] <sup>*2</sup>	Close the inner cover, and press the Resume/Cancel button to clear the error. The paper being printed at error occurrence will be ejected without printing the remaining data for the ejected paper, then printing will resume from the next page.	
	Inner cover open (print continuable). [1851] <sup>*1</sup>	Close the inner cover, and press the Resume/Cancel button.	
	Inner cover open during printing on paper (print NOT continuable). [1856] <sup>*1</sup>	Close the inner cover, and press the Resume/Cancel button to clear the error. The paper being printed at error occurrence will be ejected without printing the remaining data for the ejected paper, then printing will resume from the next page.	
	Inner cover closed during CD / DVD printing (print continuable). [1850] <sup>*1</sup>	Open the inner cover which functions as the CD / DVD tray feeder, set the CD / DVD tray in the feeder, and press the Resume/Cancel button.	
	Inner cover closed during CD / DVD printing (print NOT continuable). [1855] <sup>*1</sup>	Open the inner cover, and press the Resume/Cancel button to clear the error. The CD or DVD being printed at error occurrence will be ejected without printing the remaining data for the ejected CD or DVD, then the next print job will be done.	
7 times	Multiple ink tanks of the same color installed. [1681]	Replace the wrong ink tank(s) with the correct one(s).	
	Ink tank in a wrong position. [1680]	Install the ink tank(s) in the correct position.	
8 times	Warning: The waste ink absorber becomes almost full. [1700]	Pressing the Resume/Cancel button will exit the error, and enable printing.	The service call error, indicating the waste ink absorber is full, is likely to occur soon.
9 times	The connected digital camera or digital video camera does not support Camera Direct Printing. [2001]	Remove the cable between the camera and the printer.	
10 times	Automatic duplex printing cannot be performed. [1310]	The size of paper may not be compatible with automatic duplex printing. Press the Resume/Cancel	Data which was to be printed on the back side of

		button to eject the paper being used at error occurrence. Printing will resume from on the front side of the next page.	paper at error occurrence is skipped (not printed).
11 times	Failed in automatic print head alignment. [2500]	Press the Resume/Cancel button. - If paper is being fed at error occurrence, the error is indicated after the paper is ejected. - If the error occurs, the print head alignment values are not changed. - After exit from the error by the Resume/Cancel button, the automatic print head alignment will not be re-done.	The error is indicated when the pattern is not printed due to no ink or non-ejection of ink, or when the sensor's AD value is incorrect.
13 times	The remaining ink amount unknown. [1683]	An ink tank which has once been empty is installed. Replace the applicable ink tank with a new one.	Printing with a once-empty or refilled ink tank can damage the print head.  If printing is continued without replacing the "no-good" ink tank, press the Resume/Cancel button for 5 sec. or longer to record the use of a refilled ink tank.  Note: After the above operation, the function to detect the remaining ink amount is disabled.
14 times	Ink tank not recognized. [1684]	A non-supported ink tank is installed (the ink tank LED is turned off). Install the supported ink tanks.	
15 times	Ink tank not recognized. [1410 to 1419]	An error occurred in an ink tank (the ink tank LED is turned off). Replace the ink tank(s).	
No blinking	Access cover open. [1200]	Close the access cover.	

\*1: Only for models supporting CD / DVD printing

\*2: Only for models not supporting CD / DVD printing

## 2-2. Service Call Errors (by Cyclic Blinking in Orange (Alarm LED) and Green (Power LED), or Alarm LED Lit in Orange)

Cycles of blinking in orange (Alarm LED) and green (Power LED)	Error [Error code]	Solution (Replacement of listed parts, which are likely to be faulty)
----------------------------------------------------------------	--------------------	--------------------------------------------------------------------------

LED)		
2 times	Carriage error [5100]	- Carriage unit (QM2-2251) - Timing slit strip film (QC1-6526) - Logic board ass'y (QM2-2733)* <sup>1</sup> - Carriage motor (QK1-1500)
3 times	Line feed error [6000]	- Timing sensor unit (QM2-2683) - Timing slit disk film (QC1-6229) - Feed roller ass'y (QL2-0950) - Platen unit (QM2-2248) - Logic board ass'y (QM2-2733)* <sup>1</sup> - PAPER FEED MOTOR (QK1-1502)
4 times	Purge cam sensor error [5C00]	- Purge unit (QM2-2252) - Logic board ass'y (QM2-2733)* <sup>1</sup>
5 times	ASF (cam) sensor error [5700]	- Sheet feed unit (QM2-2278)
6 times	Internal temperature error [5400]	- Logic board ass'y (QM2-2733)* <sup>1</sup>
7 times	Waste ink absorber full [5B00]	- Ink absorber kit (QY5-0152)
8 times	Print head temperature rise error [5200]	- Print head (QY6-0059) - Logic board ass'y (QM2-2733)* <sup>1</sup>
9 times	EEPROM error [6800]	- Logic board ass'y (QM2-2733)* <sup>1</sup>
11 times	Carriage lift mechanism error [5110]	- PR lift shaft ass'y (QL2-0936) - Sheet feed unit (QM2-2278) - Logic board ass'y (QM2-2733)* <sup>1</sup> - Carriage lift sensor unit (QM2-2678)
12 times	AP position error [6A00]	- Sheet feed unit (QM2-2278) - Logic board ass'y (QM2-2733)* <sup>1</sup> - Purge unit (QM2-2252)
13 times	Paper feed position error [6B00]	- Sheet feed unit (QM2-2278) - Logic board ass'y (QM2-2733)* <sup>1</sup>
14 times	Paper feed cam sensor error [6B10]	- Sheet feed unit (QM2-2278) - Logic board ass'y (QM2-2733)* <sup>1</sup>
15 times	USB Host Vbus over current [9000]	- Logic board ass'y (QM2-2733)* <sup>1</sup>
16 times	Valve sensor error [6C00]	- Logic board ass'y (QM2-2733)* <sup>1</sup> - Purge unit (QM2-2252)
17 times	Motor driver error [6D00]	- Logic board ass'y (QM2-2733)* <sup>1</sup>
19 times	Ink tank position sensor error [6502]	- Platen unit (QM2-2248) - Logic board ass'y (QM2-2733)* <sup>1</sup>
20 times	Other hardware error	- Logic board ass'y (QM2-2733)* <sup>1</sup>

	[6500]	
Continuous alternate blinking	ROM error	- Logic board ass'y (QM2-2733)* <sup>1</sup>
Alarm LED lit	RAM error	- Logic board ass'y (QM2-2733)* <sup>1</sup>

\*1: Before replacement of the logic board ass'y, check the waste ink amount (by service test print or EEPROM information print). If the waste ink amount is 7% or more, also replace the ink absorber kit (QY5-0152) when replacing the logic board ass'y.  
[\[See Section 3-3. Adjustment / Settings, \(5\) Service mode, for details.\]](#)

## 2-3. Warnings

**Printer (no LED indications):**

Displayed warning	Remarks
Low ink	- Status monitor indication. - The ink tank lamp flashes slowly (at about a second interval).
Print head temperature rise	If the print head temperature is high when the access cover is opened, the warning is displayed* <sup>1</sup> . When the print head temperature falls, the warning is released.
Protection of excess rise of the print head temperature	If the print head temperature exceeds the specified limit, a Wait is inserted during printing,

\*1: If the warning is displayed, the carriage does not move to the ink tank replacement position when the access cover is opened.

## 2-4. Troubleshooting by Symptom

	Symptom	Solution	Remarks
Faulty operation	The power does not turn on. The power turns off immediately after power-on.	Replace the - AC adapter, or - logic board ass'y* <sup>1</sup> .	
	A strange noise occurs.	Remove foreign material, or attach a removed part if any.	
	Printing stops mid-way.	Replace the logic board ass'y* <sup>1</sup> .	
Paper feed problems	Multiple sheets feed.	Replace the - sheet feed unit, or - cassette.	
	Paper does not feed.	Remove foreign material, or replace the - sheet feed unit, or - cassette.	
	Paper feeds at an angle.	Remove foreign material, adjust the paper guide, or replace the	

		<ul style="list-style-type: none"> <li>- sheet feed unit, or</li> <li>- cassette.</li> </ul>	
Unsatisfactory print quality	No printing, or no color ejected.	Replace the <ul style="list-style-type: none"> <li>- ink tank,</li> <li>- print head*<sup>2</sup>, or</li> <li>- logic board ass'y*<sup>1</sup>,</li> </ul> remove foreign material from the purge unit caps, if any, or replace the purge unit.	
	Printing is faint, or white lines appear on printouts even after print head cleaning. Line(s) not included in the print data appears on printouts.	Remove and re-install the print head, or replace the <ul style="list-style-type: none"> <li>- ink tank,</li> <li>- print head*<sup>2</sup>,</li> <li>- purge unit, or</li> <li>- logic board ass'y*<sup>1</sup>.</li> </ul>	
	Paper gets smeared.	Feed several sheets of paper, perform bottom plate cleaning, clean the paper path with cotton swab or cloth, or clean the ASF sub-rollers.	
	A part of a line is missing on printouts.	Replace the <ul style="list-style-type: none"> <li>- ink tank, or</li> <li>- print head*<sup>2</sup>.</li> </ul>	
	Color hue is incorrect.	Replace the <ul style="list-style-type: none"> <li>- ink tank, or</li> <li>- print head*<sup>2</sup>, or</li> </ul> perform print head alignment.	
	Printing is incorrect.	Replace the logic board ass'y* <sup>1</sup> .	
	No ejection of black ink.	Replace the <ul style="list-style-type: none"> <li>- ink tank, or</li> <li>- print head*<sup>2</sup>, or</li> </ul> remove foreign material from the purge unit caps, if any, or replace the purge unit.	
	Graphic or text is enlarged on printouts.	When enlarged in the carriage movement direction, clean grease or oil off the timing slit strip film, or replace the <ul style="list-style-type: none"> <li>- timing slit strip film,</li> <li>- carriage unit, or</li> <li>- logic board ass'y*<sup>1</sup>.</li> </ul> When enlarged in the paper feed direction, clean grease or oil off the timing slit disk film, or replace the	

		<ul style="list-style-type: none"> <li>- timing slit disk film,</li> <li>- timing sensor unit, or</li> <li>- logic board ass'y*1.</li> </ul>	
	Uneven printing due to line feeding	Perform LF correction adjustment.	

\*1: Before replacement of the logic board ass'y, check the waste ink amount (by service test print or EEPROM information print). If the waste ink amount is 7% or more, also replace the ink absorber kit (QY5-0152) when replacing the logic board ass'y.

[\[See Section 3-3. Adjustment / Settings, \(5\) Service mode, for details.\]](#)

\*2: Replace the print head only after the print head deep cleaning is performed 2 times, and when the problem persists.

[To the top](#)

 <Part 1: 2. LIST OF ERROR DISPLAY / INDICATION> 



### 3. REPAIR

#### 3-1. Notes on Service Part Replacement (and Disassembling / Reassembling)

Service part	Notes on replacement*1	Adjustment / settings	Operation check
Logic board ass'y QM2-2733	<ul style="list-style-type: none"> <li>- Before removal of the logic board ass'y, remove the power cord, and allow for approx. 1 minute (for discharge of capacitor's accumulated charges), to prevent damages to the logic board ass'y.</li> <li>- Before replacement, check the waste ink amount (by service test print or EEPROM information print). If the waste ink amount is 7% or more, also replace the ink absorber kit when replacing the logic board ass'y.</li> </ul> <p><a href="#">[See 3-3. Adjustment / Settings, (5) Service mode, for details.]</a></p>	<p><b>After replacement:</b></p> <ol style="list-style-type: none"> <li>1. Initialize the EEPROM.</li> <li>2. Reset the waste ink counter.</li> <li>3. Set the destination in the EEPROM.</li> <li>4. Correct the CD / DVD and automatic print head alignment sensors.</li> <li>5. Check the ink system function.</li> </ol> <p><a href="#">[See 3-3. Adjustment / Settings, (5) Service mode, for details of 1 to 5]</a></p> <ol style="list-style-type: none"> <li>6. Perform the print head alignment in the user mode.</li> </ol>	<ul style="list-style-type: none"> <li>- EEPROM information print</li> <li>- Service test print</li> <li>- Printing via USB connection</li> <li>- Direct printing from a digital camera</li> </ul>
Ink absorber kit QY5-0152		<p><b>After replacement:</b></p> <ol style="list-style-type: none"> <li>1. Reset the waste ink counter.</li> </ol> <p><a href="#">[See 3.3. Adjustment / Settings, (5) Service mode.]</a></p>	<ul style="list-style-type: none"> <li>- Service test print</li> <li>- EEPROM information print</li> </ul>
Carriage unit QM2-2251		<p><b>At replacement:</b></p> <ol style="list-style-type: none"> <li>1. Apply grease to the sliding portions.</li> </ol> <p><a href="#">[See 3-3. Adjustment / Settings, (2) Grease application.]</a></p> <p><b>After replacement:</b></p> <ol style="list-style-type: none"> <li>1. Correct the CD / DVD and automatic print head alignment sensors.</li> </ol> <p><a href="#">[See 3.3. Adjustment / Settings, (5) Service mode.]</a></p> <ol style="list-style-type: none"> <li>2. Check the ink system function.</li> </ol> <p><a href="#">[See 3.3. Adjustment / Settings, (5) Service mode.]</a></p> <ol style="list-style-type: none"> <li>3. Perform the print head alignment in the user mode.</li> </ol>	<ul style="list-style-type: none"> <li>- Service test print (Confirm CD / DVD and automatic print head alignment sensor correction, and ink system function.)</li> </ul>
Paper feed motor QK1-1502	<ul style="list-style-type: none"> <li>- The red screws securing the paper feed motor are allowed to be loosened. (DO NOT loosen any</li> </ul>	<p><b>At replacement:</b></p> <ol style="list-style-type: none"> <li>1. Adjust the paper feed motor.</li> </ol>	

	other red screws.)	<a href="#">[See 3-3. Adjustment / Settings, (1) Paper feed motor adjustment.]</a>	
Platen unit: QM2-2248 Purge unit: QM2-2252 Waste ink tube: QC1-6458 Waste ink tube holder: QC1-6460	- By attaching the tape at the specified 2 locations, secure the waste ink tube to the waste ink tube holder.	<b>At replacement:</b> 1. To protect the waste ink tube from being pinched when reassembling the printer unit chassis into the bottom case unit, tape the tube (at 2 locations).  <a href="#">[See 3-2. Special Notes on Repair Servicing, (3) Printer unit and bottom case unit assembly.]</a>	After the printer unit is assembled in the bottom case unit, the tube conditions are not visible. For confirmation of the tube conditions, perform the manual purging 3 or 4 times, and confirm that no strange noise is heard.
Platen unit QM2-2248		<b>After replacement:</b> 1. Check the ink system function.  <a href="#">[See 3-3. Adjustment / Settings, (5) Service mode.]</a>	- Service test print
PR lift shaft ass'y QL2-0936  CL INPUT GEAR QC1-6213		<b>At replacement:</b> 1. Apply grease to the sliding portions.  <a href="#">[See 3.3. Adjustment / Settings, (2) Grease application.]</a>	- Service test print
Timing slit strip film QC1-6526	- Upon contact with the film, wipe the film with ethanol.  - Confirm no grease is on the film. (Wipe off any grease thoroughly with ethanol.)  - Do not bend the film	<b>After replacement:</b> 1. Perform the print head alignment in the user mode.	- Service test print
Timing slit disk film QC1-6229			
Print head QY6-0061		<b>After replacement:</b> 1. Perform the print head alignment in the user mode.	- Service test print

\*1: General notes:

- Make sure that the flexible cables and wires in the harness are in the proper position and connected correctly.

[\[See 3-2. Special Notes on Repair Servicing, \(2\) Flexible cable and harness wiring, connection, for details.\]](#)

- Protect the waste ink tube from being pinched when assembling the printer unit chassis into the bottom case unit.

Since the tube conditions after assembly are not visible, perform the manual purging 3 or 4 times to confirm that no strange noise is heard.

[\[See 3-2. Special Notes on Repair Servicing, \(3\) Printer unit and bottom case unit assembly, for details.\]](#)

- Do not drop the ferrite core, which may cause damage.
- Protect electrical parts from damage due to static electricity.
- Before removing a unit, after removing the power cord, allow the printer to sit for approx. 1 minute (for capacitor discharging to protect the logic board ass'y from damages).
- Do not touch the timing slit strip film and timing slit disk film. No grease or abrasion is allowed.
- Protect the units from soiled with ink.
- Protect the housing from scratches.
- Exercise caution with the red screws, as follows:
  - i. The red screws of the paper feed motor may be loosened only at replacement of the paper feed motor unit (DO NOT loosen them in other cases).
  - ii. DO NOT loosen the red screws on both sides of the main chassis, securing the carriage shaft positioning (they are not adjustable in servicing).

[To the top](#)

 <Part 1: 3. REPAIR, 3-1> 

## 3-2. Special Notes on Repair Servicing

### (1) External cover removal

- (I) With your fingers at the points indicated by the blue circle, raise and slide the left and right side covers to remove them.



- (II) Release the 2 hooks on the rear side of the printer (indicated by the blue circles).



- (III) Slide the left and right panel cover units.



(IV) Hold the left and right corners indicated by the blue circle, and lift the upper case to remove it.

Note: In removing or re-assembling the upper case, make sure not to damage the ink tank sensor and ink tank sensor cover.

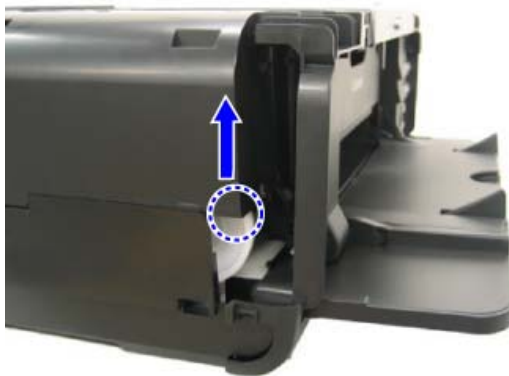

Left side

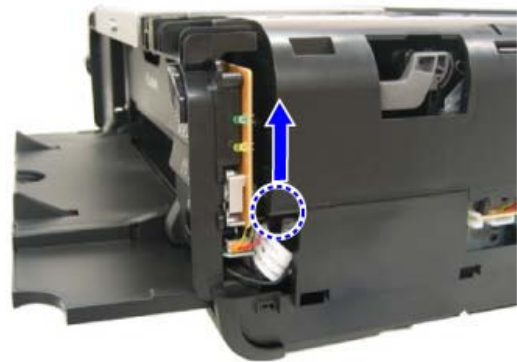

Right side

## (2) Flexible cable and harness wiring, connection

Be careful of wiring of the flexible cables and harness. Improper wiring or connection may cause breakage of a line, leading to ignition or emission of smoke.



Top view

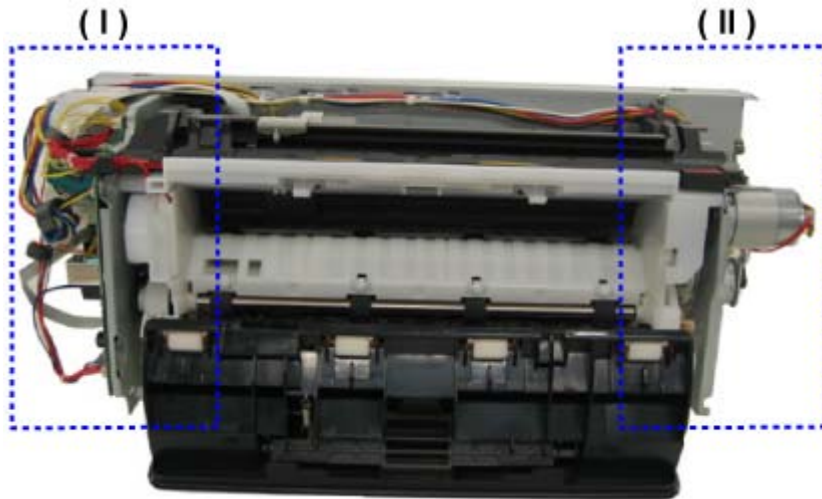

Rear view

(I) Logic board ass'y wiring (1 of 2)

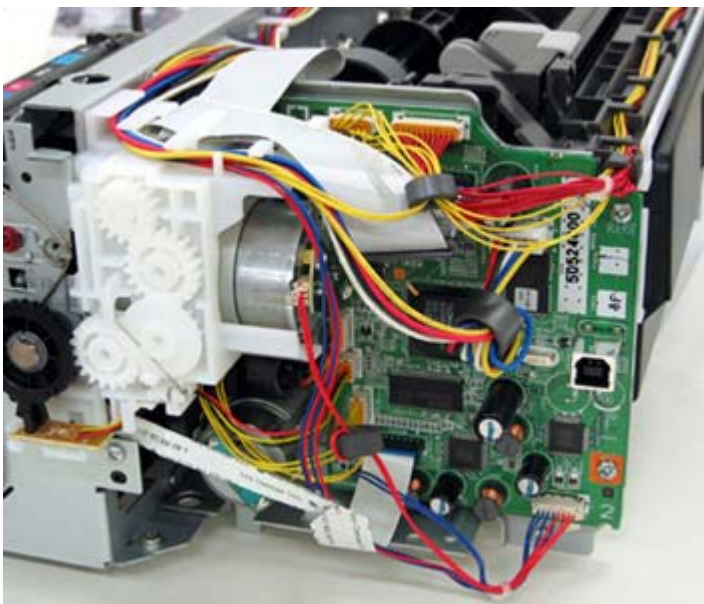

Logic board ass'y wiring (2 of 2).....Viewed from a different angle

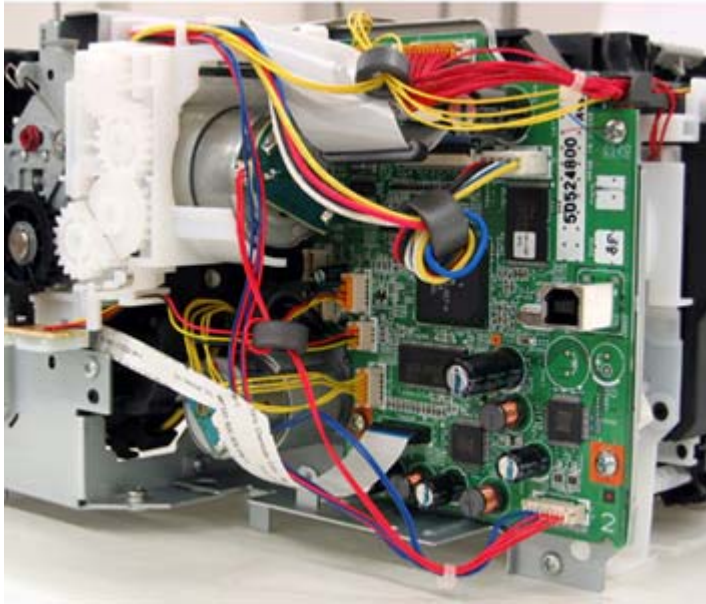

(II) Paper feed motor side wiring

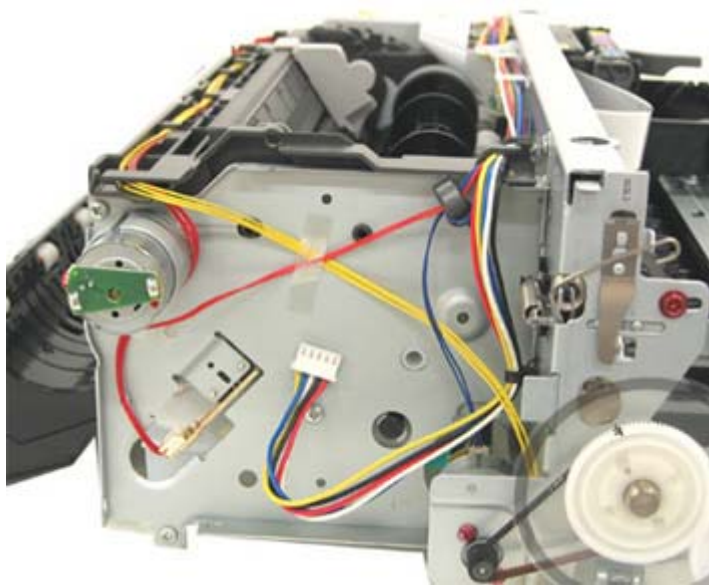

**(3) Printer unit and bottom case unit assembly**

In assembling the printer unit chassis into the bottom case unit, be cautious of the following points to protect the waste ink tube from being pinched:

- (I) At replacement of the platen unit (QM2-2248), purge unit (QM2-2252), waste ink tube (QC1-6458), or waste ink tube holder (QC1-6460), fix the waste ink tube to the printer chassis and waste ink tube holder with tape (at 2 locations).

If the tube is pinched and blocked, proper purging is prevented, resulting in ink leakage or strange noise.

(No specific tape is specified. In the sample photo below, (1) is the orange tape, and (2) is a clear adhesive tape, such as Sellotape or Scotch tape.)

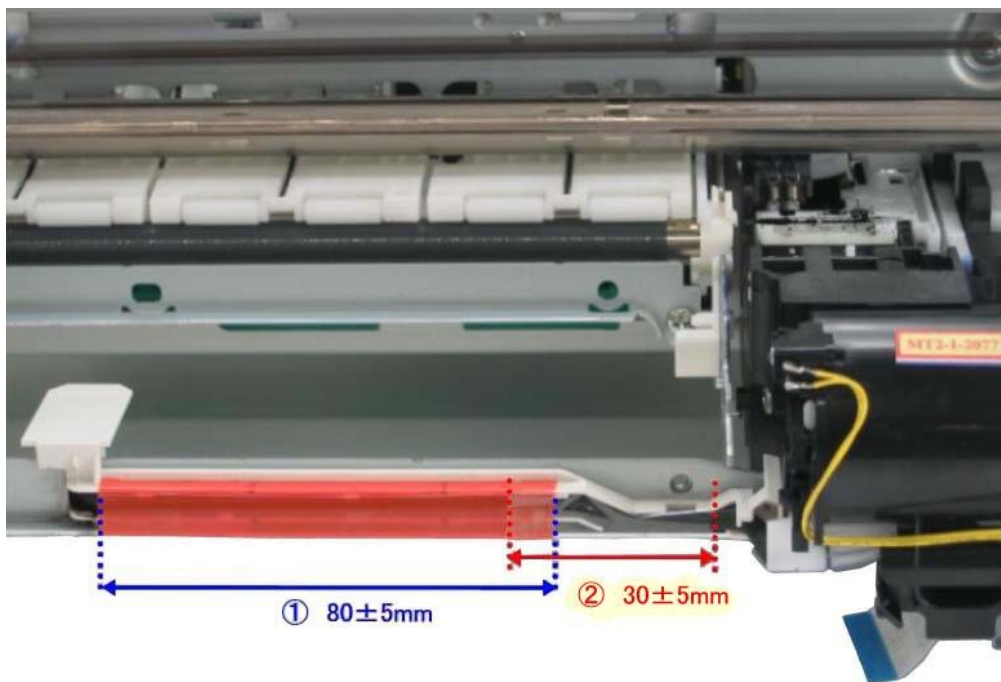

(II) After securing the waste ink tube with tape, be careful not to damage the tube in installing the printer unit chassis in the bottom case unit.

With the units assembled, the tube conditions are not visible. To confirm the tube is free from damage, perform the manual purging 3 or 4 times, and confirm that no strange noise is heard.

[Example: The tube is pinched and blocked as it is not fixed with tape.]



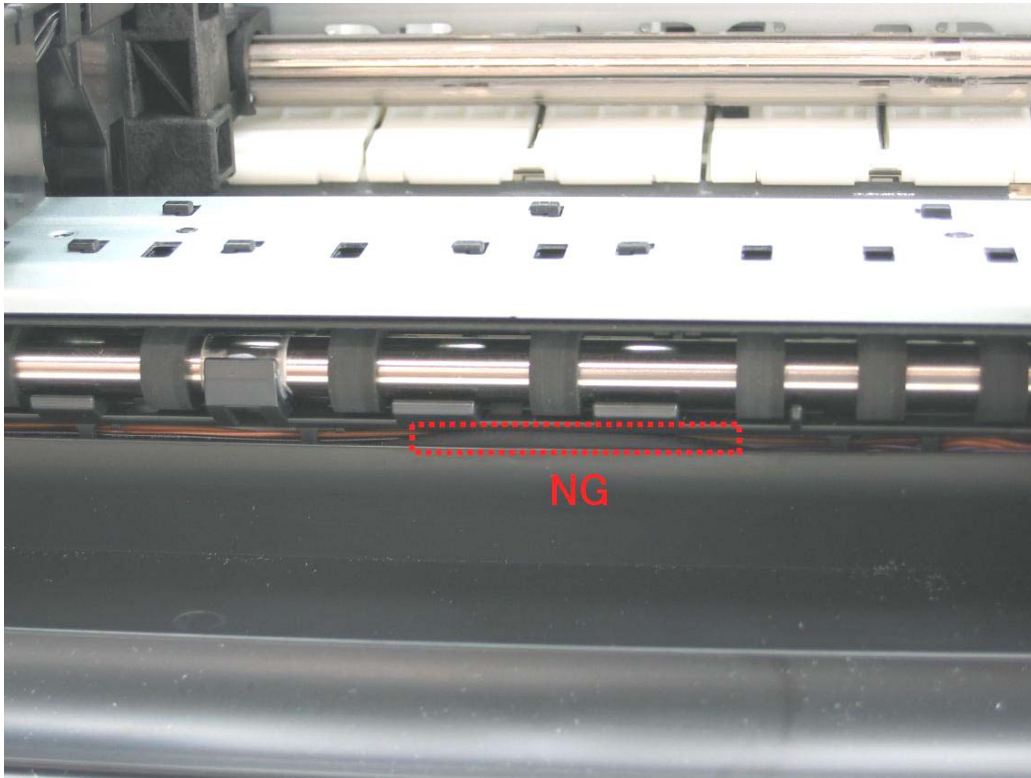

[To the top](#)

← <Part 1: 3. REPAIR, 3-2> →

### 3-3. Adjustment / Settings

#### (1) Paper feed motor adjustment

Perform the following adjustments when the paper feed motor unit is replaced:

- 1) When attaching the motor, fasten the screws so that the belt is properly stretched (in the direction indicated by the blue arrow in the figure below).
- 2) After replacement, be sure to perform the service test print, and confirm that no strange noise or faulty print operation (due to dislocation of the belt or gear, or out-of-phase motor, etc.) occurs.

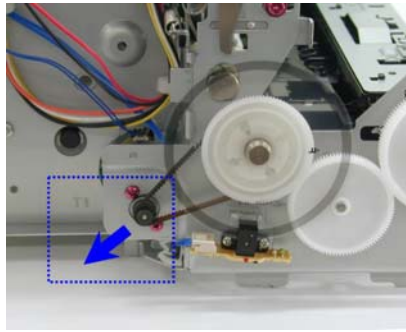

Note: The red screws securing the paper feed motor may be loosened only at replacement of the paper feed motor unit. DO NOT loosen them in other cases.

#### (2) Grease application

- 1) Printer unit

No	Part name		Where to apply grease / oil	Grease / oil name	Grease / oil amount	Number of drops*	Number of locations to apply grease / oil
1	Chassis ass'y	①	Entire surface the carriage slider contacts	Floil KG107A	27 to 54 mg	3	1
2	Chassis ass'y	②	PR lift shaft cam contact portion (at 3 locations)	Floil KG107A	9 to 18 mg	1	3
3	Adjust plate L	③	Carriage shaft cam L sliding portion	Floil KG107A	18 to 36 mg	2	1
4	Chassis ass'y	④	Carriage shaft sliding portion on the left side of the chassis (at 2 locations)	Floil KG107A	9 to 18 mg	1	2
5	Chassis ass'y	⑤	Carriage shaft sliding portion on the right side of the chassis (at 2 locations)	Floil KG107A	9 to 18 mg	1	2
6	Carriage shaft	⑥	Entire surface of the carriage shaft where the carriage unit slides	Floil KG107A	200 to 400 mg		1
7	Carriage shaft spring L	⑦	Carriage shaft sliding portion (to the end of the spring)	Floil KG107A	9 to 18 mg	1	1
8	Adjust plate R	⑧	Carriage shaft cam R sliding portion	Floil KG107A	18 to 36 mg	2	1
9	Carriage shaft	⑨	Carriage shaft surface where the carriage slides (and where machine-application of the grease is not feasible)	Floil KG107A	9 to 18 mg	1	1

\* 1 drop = 9 to 18 mg

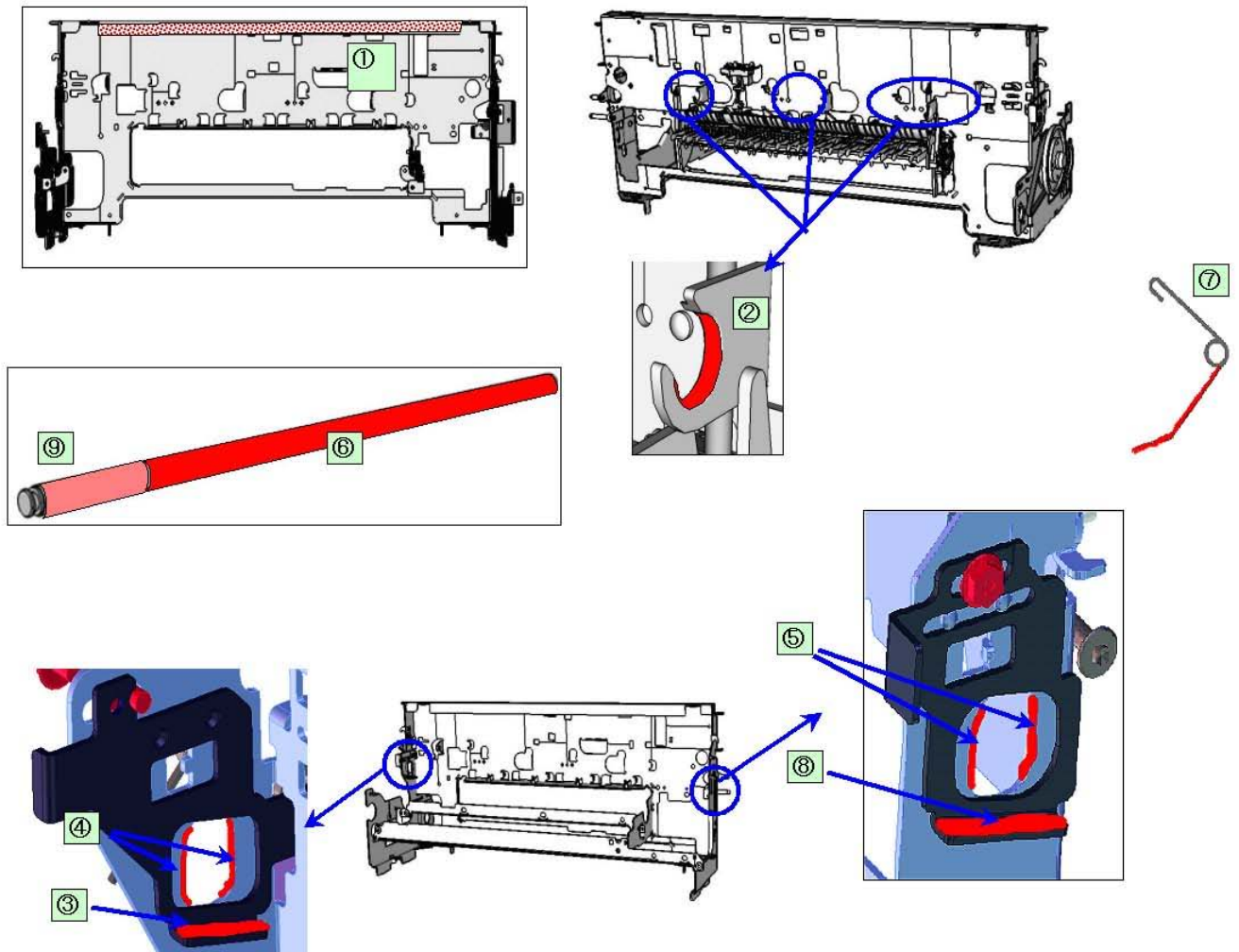

2) CL base / CL gear

No	Part name		Where to apply grease / oil	Grease / oil name	Grease / oil amount	Number of drops*	Number of locations to apply grease / oil
10	CL input gear	⑩	Joint of the CL gear base	Floil KG107A	9 to 18 mg	1	1
11	CL gear base	⑪	Outer surface of the CL idler gear cylinder	Floil KG107A	9 to 18 mg	1	1

\* 1 drop = 9 to 18 mg

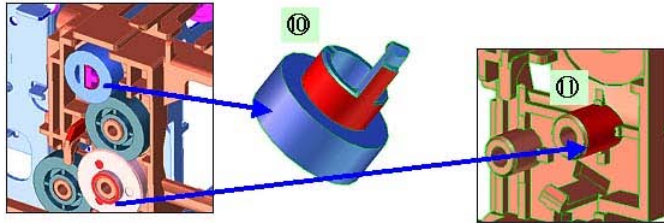

3) PR shaft / LF roller bushing

No	Part name		Where to apply grease / oil	Grease / oil name	Grease / oil amount	Number of drops*	Number of locations to apply grease / oil+H18
12	LF roller ass'y	⑫	LF roller bushing L spring contact	Floil KG107A	4.5 to 9 mg	1/2	1
13	PR shaft ass'y	⑬	PR spring sliding portion (at 4 locations)	Floil KG107A	9 to 18 mg	1	4
14	PR shaft ass'y	⑭	PR holder contact (at 4 locations)	Floil KG107A	13.5 to 27 mg	1.5	4

\* 1 drop = 9 to 18 mg

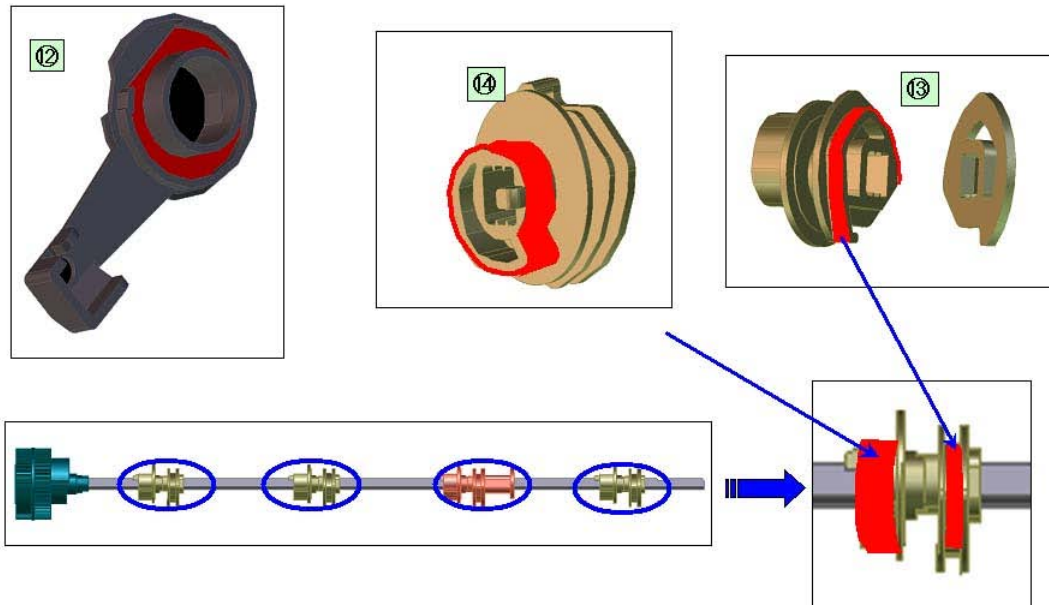

[To the top](#)

←Part 1: 3. REPAIR, 3-3 (1) to (2)→

### (3) Waste ink counter setting

When the logic board ass'y is replaced, reset the waste ink counter. In addition, according to the waste ink amount, replace the waste ink absorber (ink absorber kit). The standard amount for waste ink absorber replacement is given in the table below.

Waste ink amount*1	Ink absorber kit replacement
Less than 7%	Not required.
7% or more	Required.

\*1: Check the waste ink amount by service test print or EEPROM information print.

[See 3.3. Adjustment / Settings, (5) Service mode, for details.]

### (4) User mode

Function	Procedures	Remarks
Print head manual cleaning	<ul style="list-style-type: none"> <li>- Cleaning both black and color: See "Standalone printer operation" below.</li> <li>- Cleaning black or color separately, or both black and color: Perform from the printer driver Maintenance tab.</li> </ul>	
Print head deep cleaning	<ul style="list-style-type: none"> <li>- Cleaning black or color separately, or both black and color: Perform from the printer driver Maintenance tab.</li> </ul>	
Paper feed roller cleaning	See "Standalone printer operation" below.	
Nozzle check pattern printing	<ul style="list-style-type: none"> <li>- See "Standalone printer operation" below.</li> <li>- Perform from the printer driver Maintenance tab.</li> </ul>	
Print head alignment	<ul style="list-style-type: none"> <li>- See "Standalone printer operation" below.</li> <li>- Perform from the printer driver Maintenance tab. (Automatic head alignment, Manual head alignment)</li> </ul>	In Custom Settings of the printer driver Maintenance tab, manual print head alignment (by selecting the optimum values) as with the conventional models can be performed.
Bottom plate cleaning	Perform from the printer driver Maintenance tab.	Cleaning of the platen ribs when the back side of paper gets smeared.
Print head replacement	The print head is replaceable at the same position as for ink tank replacement. (Open the access cover. When the carriage stops at the center, the print head can be replaced.)	

<Standalone printer operation>

- 1) Turn on the printer.

- 2) Press and hold the Resume/Cancel button until the Power LED blinks in green the specified number of times listed in the table below, and release it. The operation starts.

Power LED blinking	Operation	Remarks
1 time	Print head manual cleaning	
2 times	Nozzle check pattern printing	Set a sheet of plain paper (A4 or letter) in the ASF or the cassette (according to the Paper Feed switch setting).
3 times	Paper feed roller cleaning	
4 times	Automatic print head alignment	Set a sheet of plain paper (A4 or letter) in the ASF.
5 times	Bottom plate cleaning	Fold a sheet of plain paper (A4 or letter) in half crosswise, then unfold and set it in the ASF with the folded ridge facing down.
6 times	Unspecified	
7 times	The widest head-to-paper distance setting	
8 times or more	Unspecified	

#### (5) Service mode

Function	Procedures	Remarks
Service test print - Model name - Destination - ROM version - USB serial number - Waste ink amount - CD / DVD sensor correction value - Ink system function check result - CD / DVD sensor correction result	See "Service mode operation procedures" below.	Set a sheet of A4 or letter size paper. For print sample, see <a href="#">3-4. Verification Items, (1) Service test print, &lt;Service test print sample&gt;</a> .
EEPROM initialization	See "Service mode operation procedures" below.	The following items are NOT initialized, and the shipment arrival flag is not on: - USB serial number - Destination settings - Waste ink counter - CD / DVD correction value
Waste ink counter reset	See "Service mode operation procedures" below.	If the waste ink amount is 7% or more, replace the ink absorber kit.
Destination settings	See "Service mode operation procedures" below.	

Note: At the end of the service mode, press the Power button. To protect the media sensor from being dislocated during transportation, the paper lifting plate of the sheet feeder unit will be raised.

<Service mode operation procedures>

- 1) With the printer power turned off, while pressing the Resume/Cancel button, press and hold the Power button. (DO NOT release the buttons. The Power LED lights in green to indicate that a function is selectable.)
- 2) While holding the Power button, release the Resume/Cancel button. (DO NOT release the Power button.)
- 3) While holding the Power button, press the Resume/Cancel button 2 times, and then release both the Power and Resume/Cancel buttons. (Each time the Resume/Cancel button is pressed, the Alarm and Power LEDs light alternately, Alarm in orange and Power in green, starting with Alarm LED.)
- 4) When the Power LED lights in green, press the Resume/Cancel button the specified number of time (s) according to the function listed in the table below. (Each time the Resume/Cancel button is pressed, the Alarm and Power LEDs light alternately, Alarm in orange and Power in green, starting with Alarm LED.)

Time(s)	LED indication	Function	Remarks
0 times	Green (Power)	Power off	When the print head is not installed, the carriage returns and locks in the home position capped.
1 time	Orange (Alarm)	Service test print	<a href="#">See 3-4. Verification Items, (1) Service test print.</a>
2 times	Green (Power)	EEPROM information print	<a href="#">See 3-4. Verification Items, (2) EEPROM information print.</a>
3 times	Orange (Alarm)	EEPROM initialization	
4 times	Green (Power)	Waste ink counter resetting	
5 times	Orange (Alarm)	Destination settings	After entering the destination settings mode, press the Resume/Cancel button the specified number of time(s) to select the destination. For detail, see "Destination settings procedures" below.
6 times	Green (Power)	Print head deep cleaning	(Cleaning of both black and color)
7 times	Orange (Alarm)	LF correction	
8 times	Green (Power)	CD / DVD check pattern print	Not used in servicing.
9 times	Orange (Alarm)	CD / DVD print position correction (horizontal: X direction)	Not used in servicing.
10 times	Green (Power)	CD / DVD print position correction (vertical: Y direction)	Not used in servicing.
11 to 13 times	Orange, Green, Orange (Alarm, Power, Alarm)	Return to the menu selection	
14 times	Green (Power)	Left margin correction	Not used in servicing.

15 times	Orange (Alarm)	Return to the menu selection	
----------	----------------	------------------------------	--

Note: If the Resume/Cancel button is pressed 16 or more times, the Alarm or Power LED lights steadily without any changes.

#### <Destination settings procedures>

In the destination settings mode, press the Resume/Cancel button the specified number of time(s) according to the destination listed in the table below, and press the Power button.

Time(s)	LED indication	Destination	CD / DVD print
0 times	Green (Power)	No change of the destination	
1 time	Orange (Alarm)	Japan	Supported
2 times	Green (Power)	Korea	Not supported
3 times	Orange (Alarm)	US	Not supported
4 times	Green (Power)	Europe	Supported
5 times	Orange (Alarm)	Australia	Supported
6 times	Green (Power)	Asia	Supported
7 times	Orange (Alarm)	China	Supported
8 times	Green (Power)	Taiwan	Supported
9 times	Orange (Alarm)	Return to the Destination setting mode	

Note: After setting the destination, confirm the model name and destination in service test print or EEPROM information print.

[\[See 3.4. Verification Items, \(1\) Service test print, or \(2\) EEPROM information print.\]](#)

#### <LF correction procedures>

Purpose: After replacement of the feed roller ass'y or logic board ass'y in repair servicing or in rebox operation, adjust the line feeding in the same way as done at the production site.

Operation: Print the LF correction pattern, and select the Pattern No. from 0 to 2 which contains the least streaks or lines. Press the Resume/Cancel button the same number of times as the selected Pattern No., and press the Power button. The LF correction will be done.

Procedures:

- 1) In the LF correction mode, press the Resume/Cancel button the specified number of times according to the paper to be used in LF correction listed in the table below, then press the Power button.

Time(s)	Paper Type	Paper name
1 time	High Resolution Paper	Canon HR-101
2 times	Plain paper	Canon PB Paper GF-500 (64g/m <sup>2</sup> ) Canon Office Planner
3 times		HP BrightWhite (90g/m <sup>2</sup> ) Canon Office (80g/m <sup>2</sup> )
4 times		Canon Extra (80g/m <sup>2</sup> ) STEINBEIS Vision Classic White



Note:

- The High Resolution Paper is the most desirable for LF correction printing (Canon HR-101 is used at the production site), but 6 kinds of plain paper listed in the table above can also be used in LF correction. If plain paper other than the above is used, select any one of the paper types in this step, then select Pattern No. 0 (zero) in the step 3) below.
- Each time the Resume/Cancel button is pressed, the Alarm and Power LEDs light alternately, alarm in orange and Power in green.
- If the Resume/Cancel button is NOT pressed, and only the Power button is pressed, the printer remains in the LF correction mode.
- If the Resume/Cancel button is pressed 5 times or more, then the Power button is pressed, the printer returns to the service mode menu selection.

2) The LF correction pattern for the selected paper is printed.

LF correction pattern print sample:

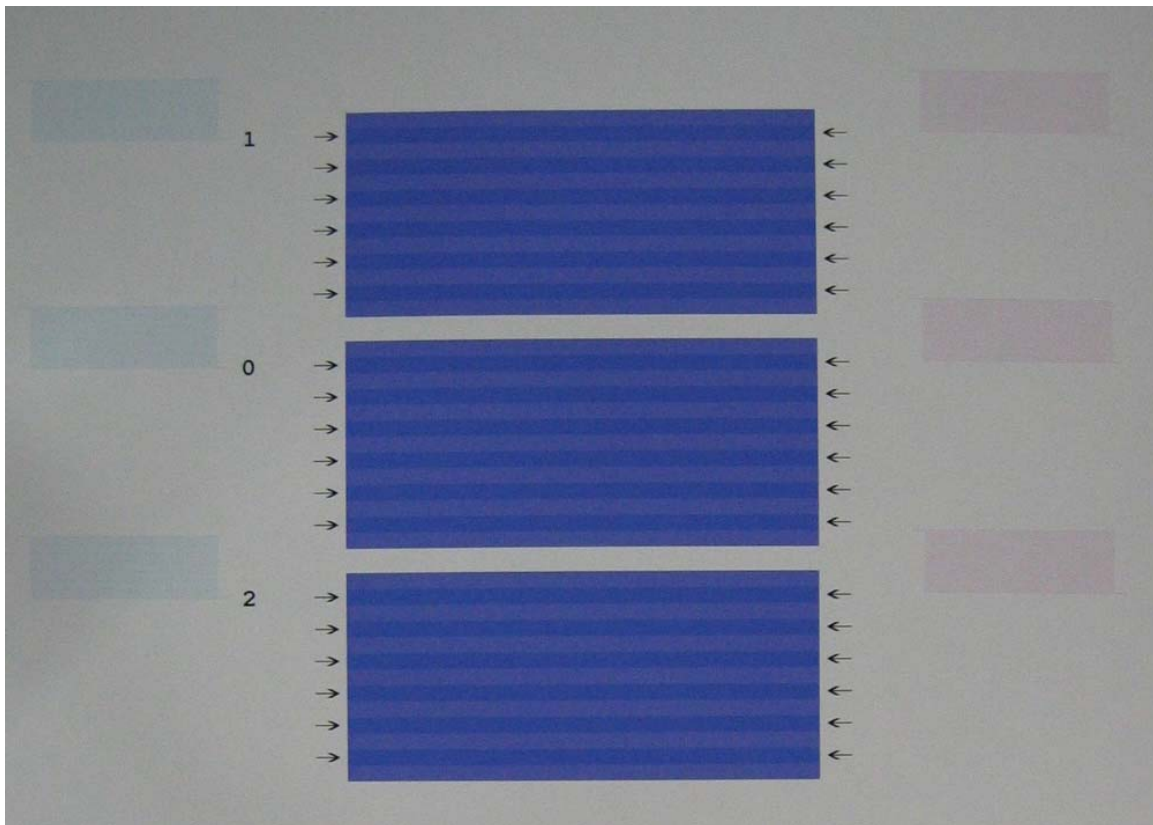

3) In the printout, select the Pattern No. in which streaks or lines (white or black) are the least noticeable, press the Resume/Cancel button the same number of time(s) as the selected Pattern No., then press the Power button.

Pattern No.	Number of times the Resume/Cancel button is pressed
1	1
0	0
2	2

Note:

- If plain paper other than the 6 kinds specified in the table in step 1) is used, select the Pattern No. 0 (zero), leave the Resume/Cancel button untouched, and press the Power button.
- Each time the Resume/Cancel button is pressed, the Alarm and Power LEDs light alternately, alarm in orange and Power in green.
- If the Resume/Cancel button is pressed 3 times or more, then the Power button is pressed, the printer returns to the service mode menu selection.

**OK**

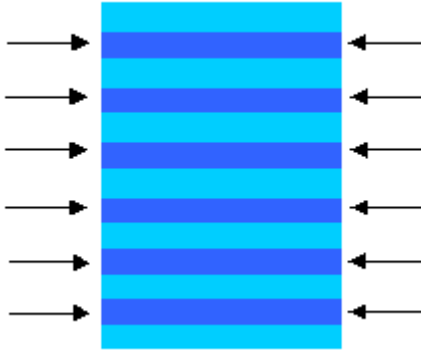

**NG**

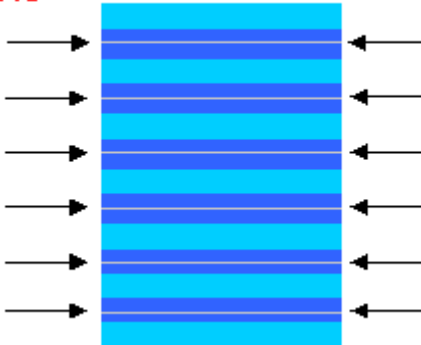

NG : streaks or lines (white or black)

- 4) The LF correction value is written to the EEPROM, and the printer returns to the service mode menu selection.

Note: The LF correction value (0, 1, or 2) can be confirmed in service test print or EEPROM information print.

[To the top](#)

[←](#) <Part 1: 3. REPAIR, 3-3 (3) to (5)> [→](#)

### 3-4. Verification Items

#### (1) Service test print

<EEPROM information contents>

On the service test print (sample below), confirm the EEPROM information as shown below. (The information is given in the upper portion of the printout.)

iP5200: Model name

US: Destination

Vx.xx: ROM version

USB (xxxxxx): USB serial number

FA = xx xx xx: Reserved for plant use

D = xxx.x: Waste ink amount (%)

CDR (+xxxxx, +yyyyy): CD / DVD sensor position correction value

LF = (x): LF correction value

AB (K = OK Y = OK ...): Ink system check result

<Print check items>

On the service test print (sample below), confirm the following items:

- Check 1, top of form accuracy: The lines shall not extend off the paper.
- Check 2, EEPROM information
- Check 3, nozzle check pattern: Ink shall be ejected from all nozzles.
- Check 4, check pattern for uneven printing due to line feeding: There shall be no remarkable streaks or unevenness.
- Check 5, LF correction pattern: There should be no white line and black line.
- Check 6, check pattern for uneven printing due to carriage movement (9600 dpi mode): There shall be no remarkable unevenness.
- Check 7, check pattern for uneven printing due to carriage movement (standard mode): There shall be no remarkable unevenness.
- Check 8, CD / DVD sensor and automatic print head alignment sensor correction: The results shall be OK.

<Service test print sample>

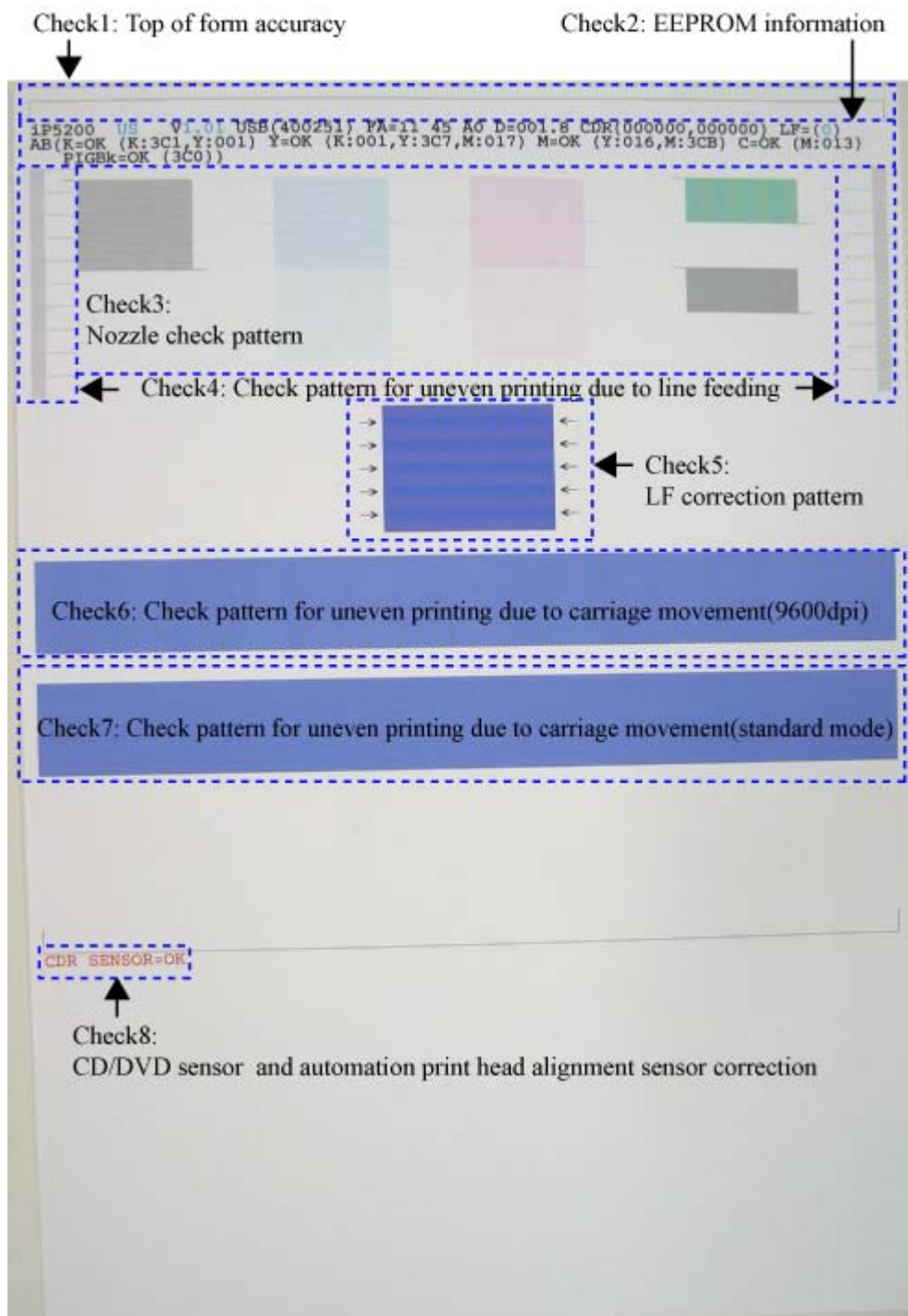

## (2) EEPROM information print

<How to read EEPROM information print>

### Print sample:

iP5200 US V1.01 IF(USB2=1) D=004.5 ST=2005/05/27-18:30  
 ER(ER0=1000 ER1=5100) LPT=2005/07/07-09:09  
 PC(M=002 R=000 T=001 D=009 C=008)  
 CLT(BK=2005/07/02-18:30 CL=2005/07/01-18:30)  
 CH=00002 CT(PBK=001 BK=010 Y=009 M=001 C=003) IS(PBK=0 BK=0 Y=0 M=0 C=0)  
 P\_ON(S=00009) A\_REG=1 M\_REG=1

UR(A(BKoe)=000 B(Coe)=000 C(Moe)=000 D(SCoe)=000 E(SMoe)=000 F(PBKoe)=000  
G(CLbi)=000 H(SCLbi)=000 I(C-SC)=000 J(M-SM)=000 K(BK-CL)=000  
L(BKbiPP)=000 M(CLbiPP)=000 N(SCLbiPP)=000 O(NZctr)=000 P(NZedge)=000

WP=0008 CDIN(LG=001 PB=000) MSD(005)

TPAGE=00085

PAGE(All=00083 PP=00035 HR+MP=00003 PR+SP+SG=00000 GP=00000 PC=00000 EV=00000)

UCPAGE(All=00083 PP=00035 HR+MP=00003 PR+SP+SG =00000 GP =00000 PC=00000  
EV=00000)

BPPAGE(All=00083 BSSP=00003 PC=00000)

CDPAGE(All=000) EDGE=00083 L=00000 CDR=00000

CDRP=(-00005,-00029) CDRS=(190) LF=0 LM=(ASF\_R:00 UT\_F:00 UT\_R:00)

Head TempBK=30.5 Head TempC=29.5 Env Temp=28.5 FF(A0 45 11)

HDEEPROM

V0001 SN=0318-A43D

LN(00000 00000 00001 00003 00001 00017 00015) ID=09

IL=(PBK=000 BK=000 Y=001 M=001 M2=001 C=000 C2=001)

#### **Printed items:**

1. Model name
2. Destination
3. ROM version
4. Connected I/F (USB2)
5. Waste ink amount
6. Installation date
7. Operator call/service call error record
8. Last printing time
9. Purging count (manual/deep cleaning/timer/dot count/ink tank replacement)
10. Cleaning time (BK/CL)
11. Print head replacement count
12. Ink tank replacement count (PBK/BK/Y/M/C)
13. Ink status (PBK/BK/Y/M/C)
14. Power-on count (soft)
15. Automatic print head alignment by user
16. Manual print head alignment by user
17. User print head alignment values (BKoe/Coe/Moe/SCoe/SMoe/PBKoe  
/CLbi/SCLbi/C-SC/M-SM/BK-CL  
/BKbiPP/CLbiPP/SCLbiPP/NZctr/NZedge)
18. Wiping count
19. Camera Direct Print-supported device connection record
20. Longest period where printing stops
21. Total feed pages
22. ASF feed pages (total, plain paper, High Resolution Paper & Matte Photo Paper,  
Photo Paper Pro & Photo Paper Plus Glossy & Photo Paper Plus Semi-gloss, Glossy Photo Paper,  
Postcard, Envelope)
23. U-turn cassette feed pages (total, plain paper, High Resolution Paper & Matte Photo Paper,  
Photo Paper Pro & Photo Paper Plus Glossy & Photo Paper Plus Semi-gloss, Glossy Photo Paper,  
postcard, envelope)
24. Auto duplex print pages (total, Photo Paper Plus Double Sided, postcard)
25. Camera Direct print pages (total)
26. Borderless print pages
27. L & 4x6 print pages
28. Number of CDs and DVDs printed
29. CD / DVD print position adjustment
30. CD / DVD sensor correction value
31. LF correction value
32. Left margin correction

value (ASF back side, U-turn front side, U-turn back side)\*1

33. Print head temperature (BK/CL) 34. Inside temperature 35. Line inspection information

\*1: not used for servicing

#### HDEEPROM

36. Version 37. Serial number

38. Lot number 39. Print head ID

40. Ink ejection level (PBK, BK, Y, M, M2, C, C2)

[To the top](#)

 <Part 1: 3. REPAIR, 3-4> 

## 4. PRINTER TRANSPORTATION

This section describes the procedures for transporting the printer for returning after repair, etc.

- 1) In the service mode, press the Power button to finish the mode, and confirm that the paper lifting plate of the sheet feeder unit is raised.
- 2) Keep the print head and ink tanks installed in the carriage.  
[See Caution 1 below.]
- 3) Turn off the printer to securely lock the carriage in the home position. (When the printer is turned off, the carriage is automatically locked in place.)  
[See Caution 2 below.]

Caution:

- (1) If the print head is removed from the printer and left alone by itself, ink (especially the pigment black ink) is likely to dry. For this reason, keep the print head installed in the printer even during transportation.
- (2) Securely lock the carriage in the home position, to prevent the carriage from moving and applying stress to the carriage flexible cable, or causing ink leakage, during transportation.

Memo:

If the print head must be removed from the printer and transported alone, perform the following:

- (1) Attach the protective cap (used when the packing was opened) to the print head (to protect the print head face from damage due to shocks).

[To the top](#)



# *Part 2*

## **TECHNICAL REFERENCE**





# 1. NEW TECHNOLOGIES

## (1) New ink tank system (PGI-5BK, CLI-8 series)

The PIXMA iP5200 utilizes a high-density print head through the FINE technologies, supporting 1 pl ultra-small ink droplets, to achieve the 9,600 dpi super-photo print quality. It is the premium photo printer offering high-speed and high quality premium photo printing with multi-paper path functionality. The new ink tanks, PGI-5BK (pigment-based BK) and CLI-8 series (dye-based BK, C, M, and Y), have an LED to prevent wrong installation of the ink tanks, and allow users to recognize the remaining ink level with the ink tanks seated in the carriage.

## (2) Premium photo printing

By the FINE technologies, 1 pl of ultra-fine ink droplet is adopted. The iP5200 provides excellent premium photo print quality without graininess at the maximum resolution of 9,600 dpi x 2,400 dpi\*1.

\*1: Printing at the minimum distance of 1/9600 inch between the dots.

## (3) Print speed

Borderless 4" x 6" photo in approx. 36 seconds (using PP-101 with standard mode)

For reference: High-speed printing at 30 ppm in monochrome printing and 24 ppm in color printing have been achieved.

## (4) New functionality in Direct Printing

Plain paper is now usable in Camera Direct Printing from a digital camera or digital video camera, if both support PictBridge.

<Other main features>

- Data/File numbers can be printed on the images.
- Face brightener
- Shooting info (Exif data)
- 35mm film style layout (Contact printing layout)

## (5) Design

As the frame design, the printer consists of the upper case, lower case, and side covers along with the paper output tray of 4 slides (contributing to increase of the paper ejection speed). With the trays retracted, the printer is only 160 mm high (10 mm lower than the iP4000). While keeping the functionality of retractable trays and cassettes, the round corners and edges of the upper part of the printer give gentle impression in a compact body.

- Double structure with side covers
- Four-panel output tray
- Front door is pulled open
- Front door has a damper

## (6) USB 2.0 Hi-Speed supported

The printer supports USB 2.0 Hi-Speed, enabling high speed data transfer in use with the computer, OS, and USB hub.

[To the top](#)

 <Part 2: 1. NEW TECHNOLOGIES> 

## 2. CLEANING MODE AND AMOUNT OF INK PURGED

To prevent printing problems due to bubbles, dust, or ink clogging, print head cleaning is performed before the start of printing (when the cleaning flag is on), except in the following cases:

- Cleaning on arrival: Performed when the access cover is closed.
- Manual cleaning / deep cleaning: Performed manually.

<Cleaning mode list>

Black: Pigment-based black

Color: Dye-based black, cyan, magenta, yellow

Condition	Details	Amount of ink used (g) (in the normal temperature/humidity environment)	Est. required time (sec.) (not including the time of opening the caps)
On arrival of the printer (All in sequence)	First to third cleaning after shipped from the plant.	0.57 (Black) 2.25 (Color)	100
Dot count cleaning (Blackのみ)	When the specified number of dots are printed since the previous Black cleaning.	0.20 (Black)	35 (Black)
Timer cleaning - 0 <sup>*1</sup> (Black only)	If 24 to 60 hours have elapsed since the previous Black cleaning till the start of the next printing.	0.20 (Black)	35 (Black)
Timer cleaning - 1 (Black only)	If 60 to 96 hours have elapsed since the previous Black cleaning till the start of the next printing.		
Timer cleaning - 2 (Black only)	If 96 to 120 hours have elapsed since the previous Black cleaning till the start of the next printing.		
Timer cleaning - 3 <sup>*2</sup> (Black/Color)	If 120 to 336 hours have elapsed since the previous Black/Color cleaning till the start of the next printing.	0.20 (Black) 0.66 (Color)	35 (Black) 40 (Color)
Timer cleaning - 4 (All in sequence)	If 336 to 504 hours have elapsed since the previous Black/Color cleaning till the start of the next printing.	0.57 (Black) 1.06 (Color)	80
Timer cleaning - 5 (All in sequence)	If 504 to 720 hours have elapsed since the previous Black/Color cleaning till the start of the next printing.		80

Timer cleaning - 6 (All in sequence)	If 720 to 1,080 hours have elapsed since the previous Black/Color cleaning till the start of the next printing.		80
Timer cleaning - 7 (All in sequence)	If 1,080 to 2,160 hours have elapsed since the previous Black/Color cleaning till the start of the next printing.	1.27 (Black) 1.06 (Color)	85
Timer cleaning - 8 (All in sequence)	If 2,160 to 4,320 hours have elapsed since the previous Black/Color cleaning till the start of the next printing.	1.95 (Black) 1.06 (Color)	90
Timer cleaning - 9 (All in sequence)	If 4,320 to 8,640 hours have elapsed since the previous Black/Color cleaning till the start of the next printing.	1.95 (Black) 1.06 (Color)	90
Timer cleaning - 10 (All in sequence)	If 8,640 or longer hours have elapsed since the previous Black/Color cleaning till the start of the next printing.		90
At print head replacement (All in sequence)	When the print head is removed and installed.	0.57 (Black) 2.25 (Color)	100
At ink tank replacement* <sup>3</sup> (Black/Color/All in sequence)	When an ink tank is replaced (without the print head removal or re-installation)	0.38 (Black) 1.06 (Color)	80 (All in sequence) 40 (Black) 65 (Color)
Manual cleaning (Black/Color/All at the same time)	- Via the operation panel (All at the same time only) - Via the printer driver (Selectable from Black, Color, or All at the same time)	0.20 (Black) 0.65 (Color)	45 (All at the same time) 35 (Black) 40 (Color)
Deep cleaning (Black/Color/All at the same time)	Via the printer driver (Selectable from Black, Color, or All at the same time)	1.95 (Black) 1.06 (Color)	90 (All at the same time) 45 (Black) 65 (Color)
If the print head has not been capped before power-on (All in sequence)		0.38 (Black) 1.06 (Color)	80 (All in sequence)

\*1: When 24 to 60 hours have elapsed since the previous Black cleaning, timer cleaning - 0 is performed. However, this cleaning will be conducted up to 5 times from the printer installation, and no further timer cleaning - 0 will be performed.

\*2: The period of time since the previous cleaning is counted by Black and Color separately. For this reason, the cleaning mode may differ according to Black or Color.

\*3: When only the black ink tank is replaced, Black cleaning is performed. One of the color ink

tanks is replaced, Color cleaning is performed. Both the black and color ink tanks are replaced,  
All-at-the-same-time cleaning is performed.

[To the top](#)

 **<Part 2: 2. CLEANING MODE AND AMOUNT OF INK PURGED>** 

### 3. PRINT MODE

#### 3-1. Resolution

	Default setting
	Selectable in the printer driver Main tab
	Selectable after clicking Custom in the Main tab

Ink used	PigBk	PGI-5BK
	C	CLI-8C (large droplet)
	M	CLI-8M (large droplet)
	Y	CLI-8Y
	k	CLI-8BK
	c	CLI-8C (small droplet)
	m	CLI-8M (small droplet)

#### (1) Normal color printing

Paper type (Canon specialty paper)	Item	Printer driver Custom setting				
		5 Fast	4	3	2	1 Fine
Plain Paper	Print Quality	Custom	Fast	Standard	High	
	Resolution HxV(dpi)	300x300	300x300	1200x1200	1200x2400	
	Print control	1 pass-Bi	1 pass-Bi	1 pass-Bi	4 pass-Bi	
Photo Paper Pro (PR-101)	Print Quality			Standard	High	Custom
	Resolution HxV(dpi)			1200x2400	1200x2400	9600x2400
	Print control			4 pass-Bi	6 pass-Bi	16 pass-Bi
Photo Paper Plus Glossy (SP-101/SG-101)	Print Quality		Fast	Standard	High	
	Resolution HxV(dpi)		1200x2400	1200x2400	1200x2400	
	Print control		3 pass-Bi	4 pass-Bi	6 pass-Uni	
Photo Paper Plus Glossy Double Sided (SP-101D)	Print Quality			Standard	High	
	Resolution HxV(dpi)			1200x2400	1200x2400	
	Print control			4 pass-Bi	6 pass-Bi	
Matte Photo Paper (MP-101)	Print Quality			Standard	High	
	Resolution HxV(dpi)			1200x2400	1200x2400	
	Print control			4 pass-Bi	6 pass-Bi	
Glossy Photo Paper (GP-401/EC-101)	Print Quality			Standard	High	
	Resolution HxV(dpi)			1200x2400	1200x2400	
	Print control			4 pass-Bi	6 pass-Bi	
High Resolution Paper (HR-101)	Print Quality			Standard	High	
	Resolution HxV(dpi)			1200x2400	1200x2400	
	Print control			4 pass-Bi	6 pass-Bi	
Ink Jet Hagaki	Print Quality		Fast	Standard	High	
	Resolution HxV(dpi)		1200x1200	1200x2400	1200x2400	
	Print control		2 pass-Bi	3 pass-Bi	4 pass-Bi	
Hagaki/Envelope	Print Quality			Standard	High	
	Resolution HxV(dpi)			1200x1200	1200x1200	
	Print control			2 pass-Bi	4 pass-Bi	
Printable disc (recommended)	Print Quality			Fast	Standard	High
	Resolution HxV(dpi)			1200x2400	1200x2400	1200x2400
	Print control			4 pass-Bi	6 pass-Bi	8 pass-Bi
Printable disc (others)	Print Quality			Fast	Standard	High
	Resolution HxV(dpi)			1200x2400	1200x2400	1200x2400
	Print control			4 pass-Bi	6 pass-Bi	8 pass-Bi
T-Shirt Transfers (TR-301)	Print Quality			High		
	Resolution HxV(dpi)			1200x1200		
	Print control			6 pass-Bi		
Transparencies (CF-102)	Print Quality			Standard	High	
	Resolution HxV(dpi)			1200x1200	1200x1200	
	Print control			4 pass-Bi	6 pass-Bi	
Other Photo Paper	Print Quality			Standard		
	Resolution HxV(dpi)			1200x2400		
	Print control			8 pass-Bi		

#### 2) Grayscale printing

Paper type (Canon specialty paper)	Item	Printer driver Custom setting				
		5 Fast	4	3	2	1 Fine
Plain Paper	Print Quality	Custom	Fast	Standard	High	
	Resolution HxV(dpi)	300x300	300x300	600x600	600x600	
	Print control	1 pass-Bi	1 pass-Bi	1 pass-Bi	4 pass-Bi	
Hagaki/Envelope	Print Quality			Standard	High	
	Resolution HxV(dpi)			600x600	600x600	
	Print control			2 pass-Uni	4 pass-Uni	

#### (3) Borderless printing

Paper type (Canon specialty paper)	Item	Printer driver Custom setting				
		5 Fast	4	3	2	1 Fine
Plain Paper	Print Quality Resolution HxV(dpi) Print control Ink used			Standard 1200x1200 2 pass-Bi C/M/Y/k		
Hagaki	Print Quality Resolution HxV(dpi) Print control Ink used			Standard 1200x1200 2 pass-Bi C/M/Y/k	High 1200x1200 4 pass-Bi C/M/Y/k	
Photo Paper Pro (PR-101)	Print Quality Resolution HxV(dpi) Print control Ink used			Standard 1200x2400 4 pass-Bi C/M/Y/c/m/k	High 1200x2400 6 pass-Bi C/M/Y/c/m/k	Custom 9600x2400 16 pass-Bi C/M/Y/c/m/k
Photo Paper Plus Glossy (SP-101/SG-101)	Print Quality Resolution HxV(dpi) Print control Ink used		Fast 1200x2400 3 pass-Bi C/M/Y/c/m/k	Standard 1200x2400 4 pass-Bi C/M/Y/c/m/k	High 1200x2400 6 pass-Bi C/M/Y/c/m/k	
Glossy Photo Paper (GP-401/EC-101)	Print Quality Resolution HxV(dpi) Print control Ink used			Standard 1200x2400 4 pass-Bi C/M/Y/c/m/k	High 1200x2400 6 pass-Bi C/M/Y/c/m/k	
Matte Photo Paper (MP-101)	Print Quality Resolution HxV(dpi) Print control Ink used			Standard 1200x2400 4 pass-Bi C/M/Y/c/m/k	High 1200x2400 6 pass-Bi C/M/Y/c/m/k	
Ink Jet Hagaki	Print Quality Resolution HxV(dpi) Print control Ink used		Fast 1200x1200 2 pass-Bi C/M/Y/k	Standard 1200x2400 3 pass-Bi C/M/Y/c/m/k	High 1200x2400 4 pass-Bi C/M/Y/c/m/k	
Other Photo Paper	Print Quality Resolution HxV(dpi) Print control Ink used			Standard 1200x2400 8 pass-Bi C/M/Y/c/m/k		

(4) Duplex printing

Paper type (Canon specialty paper)	Item	Printer driver Custom setting				
		5 Fast	4	3	2	1 Fine
Plain Paper	Print Quality Resolution HxV(dpi) Print control Ink used	Custom 300x300 1 pass-Bi PigBk/C/M/Y	Fast 300x300 1 pass-Bi PigBk/C/M/Y	Standard 1200x1200 1 pass-Bi PigBk/C/M/Y	High 1200x2400 4 pass-Bi PigBk/C/M/Y/c/m	
Plain Paper * Borderless Printing	Print Quality Resolution HxV(dpi) Print control Ink used			Standard 1200x1200 2 pass-Bi C/M/Y/k		
Hagaki	Print Quality Resolution HxV(dpi) Print control Ink used			Standard 1200x1200 2 pass-Bi PigBk/C/M/Y/k	High 1200x1200 4 pass-Bi PigBk/C/M/Y/k	
Photo Paper Plus Glossy Double Sided (SP-101D)	Print Quality Resolution HxV(dpi) Print control Ink used			Standard 1200x2400 4 pass-Bi C/M/Y/c/m/k	High 1200x2400 6 pass-Bi C/M/Y/c/m/k	
Ink Jet Hagaki * Only when using an application software for Hagaki, double sided printing is available	Print Quality Resolution HxV(dpi) Print control Ink used		Fast 1200x1200 2 pass-Bi C/M/Y/k	Standard 1200x2400 4 pass-Bi C/M/Y/c/m/k	High 1200x2400 6 pass-Bi C/M/Y/c/m/k	

(5) Camera Direct printing

Paper type (Canon specialty paper)	Item	Printer driver Custom setting					Camera Direct print mode
		5 Fast	4	3	2	1 Fine	
Plain Paper(*1) (*1) Prints with Camera Direct print mode which is not included in printer driver.	Print Quality Resolution HxV(dpi) Print control Ink used						1200x1200 4 pass-Bi PigBk/C/M/Y
Photo Paper Pro (PR-101)	Print Quality Resolution HxV(dpi) Print control Ink used				1200x2400 6 pass-Bi C/M/Y/c/m/k		
Photo Paper Plus Glossy (SP-101/SG-101)	Print Quality Resolution HxV(dpi) Print control Ink used				1200x2400 6 pass-Bi C/M/Y/c/m/k		

To the top

← <Part 2: 3. PRINT MODE> →

#### 4. FAQ (Problems Specific to the iP5200 and Corrective Actions)

No.	*	Function	Phenomenon	Condition	Cause	Corrective action	Possible call or complaint
1	B	Print results	Skewed paper feeding	- Paper feeding from the cassette, Photo Paper Plus Double Sided, 5 x 7 size	Due to its mechanism, contact of the PF pinch rollers to the 5 x 7 size paper is uneven, which is likely to cause skewed paper feeding.	Change the paper feeding method from the cassette to the auto sheet feeder.	- Paper feeds at an angle. - A margin appears on printouts.
2	B	Paper feed	Improper paper feeding: - Multi-feeding - Skewed paper feeding - Paper jam	- Paper feeding from the ASF - Plain paper - Highest print speed (Custom setting to 5) - In the high temperature and high humidity environment - In the low temperature and low humidity environment - With the maximum amount of paper set (13 mm)	In the high temperature and high humidity environment, paper becomes wavy; in the low temperature and low humidity environment, paper curls significantly. When the maximum amount of paper is set in the ASF, and if the paper-return tab fits in a wave or curl of the paper, the tab slips and does not catch paper properly, causing paper feed problems.	- Reduce the amount of paper set in the ASF to half (approx. 5 mm high).	- Multiple sheets of paper feed at the same time. - Paper feeds at an angle. - A paper jam occurs.
3	C	Print results	Skewed paper feeding (at the level of +/- 1%)	- Paper feeding from the ASF - Credit Card size	Since coaxial tolerance between the pinch roller and the LF roller, which determines the paper feed alignment, is 0.2mm, skewed paper feeding can occur. However, according to the field data of current models, the skewness level caused by the coaxial tolerance of 0.2mm is within the criteria of +/- 1%, thus the phenomenon is left as is.	- Align the paper guide to the paper edge tighter than usual.	- Paper feeds at an angle. - A margin appears on printouts.

4	A	Print results	Soiling on the back side of paper (lines or streaks parallel to the paper feed direction)	<ul style="list-style-type: none"> <li>- After continuous borderless printing of small sized paper (such as 4 x 6), when a larger sized paper (such as A4) is printed.</li> <li>- With Photo Paper Plus Double Sided or postcards, the phenomenon is likely to be noticeable and to be complained of by users, as printing is performed on both sides of such paper.</li> </ul>	In borderless printing, printing is performed to the size slightly larger than the paper size, and ink off the paper is absorbed by the platen's ink absorber. Absorbed ink may attach to the platen rib(s) after several dozen sheets are printed, causing soiling at the leading edge of paper or on the back side of paper.	<ol style="list-style-type: none"> <li>1. Perform Bottom plate cleaning (from the printer driver) up to 3 times*<sup>1</sup>.</li> <li>2. If soiling on the paper still remains after 3 times of Bottom plate cleaning, wipe the platen rib (s) and their surroundings with a cotton swab.</li> </ol>	<ul style="list-style-type: none"> <li>- Paper gets smeared.</li> <li>- The back side of paper gets smeared.</li> </ul>
5	B	Print results	Soiling on paper in automatic duplex printing (lines or streaks perpendicular to the paper feed direction)	<ul style="list-style-type: none"> <li>- Automatic duplex printing (Photo Paper Plus Double Sided, postcards, plain paper)</li> </ul>	On the rib(s) inside the sheet feed unit used for duplex printing, ink mist may accumulate, smearing paper.	<p><b>Temporary operational solution:</b> Cancel automatic duplex printing, and manually print each side of paper.</p> <p><b>Cleaning by user:</b></p> <ol style="list-style-type: none"> <li>1. Perform Bottom plate cleaning (from the printer driver) up to 3 times*<sup>1</sup>.</li> <li>2. If soiling on the paper still remains after 3 times of Bottom plate cleaning, wipe the platen rib (s) and their surroundings with a cotton swab.</li> </ol> <p>If the phenomenon persists after conducting 1 and 2, servicing is required.</p> <p><b>Service:</b> Wipe any soiling or dirt off from the sheet feed unit</p>	<ul style="list-style-type: none"> <li>- Paper gets smeared.</li> <li>- The back side of paper gets smeared.</li> <li>- Even after Bottom plate cleaning was performed, and the platen ribs were cleaned with cotton swab, paper gets smeared.</li> </ul>



						and the bottom case unit ribs*2.	
6	C	Print results	Scratches on paper	<ul style="list-style-type: none"> <li>- PP-101D, PP-101, PR-101, SG-101, etc.</li> <li>- Paper feeding from the cassette</li> </ul>	Scratches on the PF return lever due to paper feeding from the cassette, and duplex printing path.	<ul style="list-style-type: none"> <li>- Change the paper feeding method from the cassette to the auto sheet feeder.</li> <li>- If automatic duplex printing is performed, cancel it, and, by setting only a single sheet of paper in the auto sheet feeder, manually print each side of paper.</li> </ul>	<ul style="list-style-type: none"> <li>- Paper is scratched.</li> <li>- Marks appear on printed paper.</li> </ul>
				<ul style="list-style-type: none"> <li>- PP-101D, PP-101, PR-101, SG-101, etc.</li> <li>- Paper feeding from the ASF</li> <li>- Multiple number of sheets loaded</li> </ul>	When multiple sheets of paper are set, the back side of paper being picked up scratches the front side of paper beneath (especially where the paper feed rollers contact when picking up the paper).	Set only a single sheet of paper in the auto sheet feeder.	
7	C	Print results	Soiling on paper	The printer has been used for a long period of time with the ASF cover closed before printing is performed using the ASF.	<p>Due to ink mist attached to the ASF sub-pick-up rollers.</p> <p>If printing is done from the cassette with the ASF cover closed, ink mist is kept inside the printer, attaching to the ASF sub-pick-up rollers.</p> <p>Since the sub-rollers usually do not contact the paper, ink mist can easily accumulate, especially during printing on small-sized paper which never contacts the sub-rollers.</p>	Clean the ASF sub-rollers (see *3 for details.)	
			Skewed paper feeding	<ul style="list-style-type: none"> <li>- SG-101</li> <li>- Paper feeding from the ASF</li> </ul>	When 10 sheets of paper are set in the ASF, and if	<ul style="list-style-type: none"> <li>- Straighten the paper.</li> <li>- Set 5 or less</li> </ul>	<ul style="list-style-type: none"> <li>- Paper feeds at an angle.</li> <li>- A margin</li> </ul>

8	B	Print results		- 10 sheets (max.) set in the ASF	they warp significantly, the warping portions of paper get over the cover guide, not being aligned along the guide properly.	sheets of paper in the ASF.	appears on printouts.
9	B	Print results	Uneven printing at the trailing edge of paper	- In the low temperature and low humidity environment	Due to decrease of the friction coefficient of the paper ejection rollers, or due to inaccuracy of the print head alignment	- Perform Bottom plate cleaning. - Perform manual print head alignment.	Uneven printing at the bottom of paper

\*1: Change the paper in each Bottom plate cleaning. The cleaning can end when paper does not get any soiling.

\*2: Locations to clean in servicing when soiling on paper in automatic duplex printing persists:

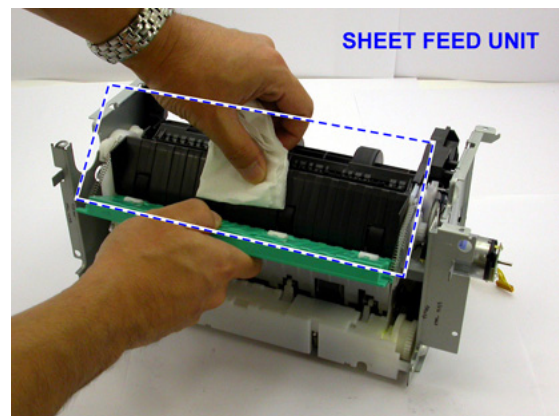
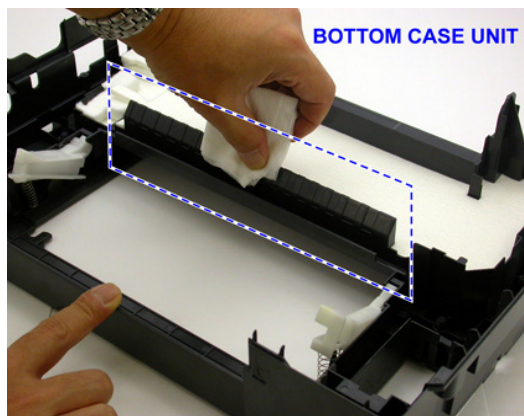

\*3: How to prepare and set the ASF sub-roller cleaning sheet:

- 1) Fold a sheet of plain paper lengthwise in half.

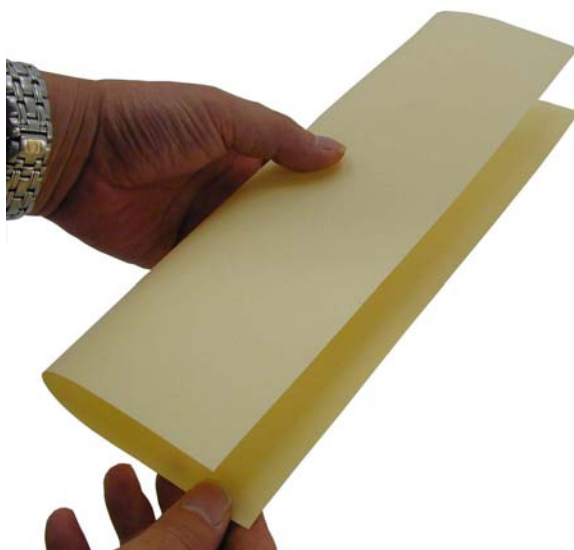

- 2) Fold the paper at approx. 60 mm from the end, and fold the folded end in half backward, as shown below.

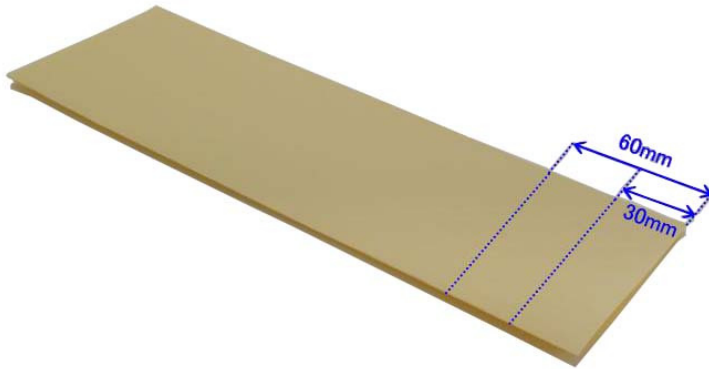

- 3) Moisten the folded end portion (indicated by the blue circle in the figure below) using a wipe, and set the paper in the ASF so that the moistened edge of the paper contacts the 2 sub-rollers. Then, fold the other end of the paper along the ASF cover edge to hook the paper to the ASF cover, as shown below.



- 4) Press and hold the Resume/Cancel button until the Power LED blinks 3 times, then release the button to perform the paper feed roller cleaning. See "[Stand alone printer operation](#)," for details.

\* Occurrence level:

A: The symptom is likely to occur frequently. (Caution required)

B: The symptom may occur under certain conditions, but likeliness is assumed very low in practical

usage.

C: The symptom is unlikely to be recognized by the user, and no practical issues are assumed.

[To the top](#)

[← <Part 2: 4. FAQ> →](#)

# *Part 3*

## **APPENDIX**



## PIXMA iP5200 Specifications

### <Printer>

Type	Desktop serial color bubble jet printer																		
Paper feeding method	Auto sheet feed (ASF, cassette, automatic duplex printing, CD / DVD printing*1)																		
Resolution	9,600 x 2,400dpi (Max.)																		
Throughput (target value)	<p>- 4 x 6, borderless printing: Approx. 36 sec. (standard mode, PP-101, Full Page SCID No. 2)</p> <p>- Camera Direct Printing: Approx. 1 minute and 19 sec. (4 x 6, borderless printing, PP-101, default settings)</p> <p>For reference:</p> <table border="0"> <tr> <td></td> <td>Fast</td> <td>Standard</td> <td colspan="2"></td> </tr> <tr> <td>Black (Fine Black)</td> <td>30ppm</td> <td>15.0ppm</td> <td colspan="2"></td> </tr> <tr> <td>Color (Fine Color)</td> <td>24ppm</td> <td>11.7ppm</td> <td colspan="2"></td> </tr> </table>					Fast	Standard			Black (Fine Black)	30ppm	15.0ppm			Color (Fine Color)	24ppm	11.7ppm		
	Fast	Standard																	
Black (Fine Black)	30ppm	15.0ppm																	
Color (Fine Color)	24ppm	11.7ppm																	
Printing direction	Bi-directional, uni-directional																		
Print width	Max. 203.2mm (216mm in borderless printing)																		
Interface	USB 2.0 Hi-Speed																		
ASF stacking capacity	Plain paper: Max. 13mm (Approx. 150 sheets of 64g/m <sup>2</sup> paper)																		
Paper weight	64 to 105g/m <sup>2</sup>																		
Detection functions	Access cover open, Presence of print head / ink tanks, Opening / Closing of front door, Remaining ink amount (optical / dot count), Printing position, Paper presence, Paper end sensor, Waste ink amount, Internal temperature, Pick-up roller, Paper feed roller position, Carriage position, Head-to-paper distance, Supported camera direct printing device, Presence of CD / DVD																		
Acoustic noise (Highest print quality)	<p>- Highest print quality settings: Approx. 34.7dB</p> <p>- Quiet mode: Approx. 34.3dB</p>																		
Environmental requirements	During operation	Temperature	5C to 35C (41F to 95F)																
		Humidity	10%RH to 90%RH (no condensation)																
	Non operation	Temperature	0C to 40C (32F to 104F)																
		Humidity	5%RH to 95%RH (no condensation)																
Power supply	Power supply voltage, frequency	Power consumption	Standby	Power-off															
	AC 100 to 120V, 50/60Hz	Approx. 17W	Approx. 0.8W	Approx. 0.4W															
	AC 220 to 240V, 50/60Hz	Approx. 17W	Approx. 0.8W	Approx. 0.4W															
External dimensions	<p>Printer:</p> <p>With the paper support and output tray retracted:</p> <p>Approx. 444 (W) x 309 (D) x 160 (H) mm</p> <p>Approx. 17.7 (W) x 12.3 (D) x 6.4 (H) inches</p>																		
Weight	Approx. 7.3kg, not including print head and optional units																		
Related standards (Printer, Adapter)	<p>Electromagnetic radiance: FCC, IC, CE Mark, Taiwan EMC, C-tick, CCC (Chinese EMC), Korea MIC, Gost-R</p> <p>Electrical safety: UL, C-UL, CB Report, CE Mark, GS, Gost-R, FT, SASO, CCC(Safety), SPRING, Korea EK, IRAM (Argentine Safety)</p> <p>Environmental regulations: RoHS (EU), WEEE (EU), Korea Package Recycle Law, Green Point (Germany), Energy Star</p>																		
Serial number location	On the carriage flexible cable holder (visible on the right of the carriage after the printer is turned on, the access cover is opened, and the carriage moves to the																		

	center.)
Remaining ink amount detection	Available (automatic detection by optical method and dot count, enabled at default)
Paper type detection	Not available
Print head alignment	Available (automatic or manual alignment via driver utilities, or the Resume/Cancel button in Camera Direct Printing, automatic alignment at default)

\*1: Only for CD / DVD printing supported regions

#### <Print head>

Type	Single head with 5 removable ink tanks (each color)
Print head	Black: 512 nozzles (600dpi), 30pl (pigment-based black) Color: 512 nozzles x 6 (1,200dpi), 1pl / 5pl (cyan, magenta), 5pl (black, yellow)
Ink color	Pigment-based black, Dye-based black, cyan, magenta, yellow
Ink tank	PGI-5BK (pigment-based), CLI-8BK/C/M/Y (dye-based)
Weight (Net)	Print head, approx. 60g
Supply method	As a service part (not including ink tanks)
Part number	QY6-0061-000

#### <Supported ink tanks>

Model	Destination	Pigment-based	Dye-based			
			CLI-8BK	CLI-8C	CLI-8M	CLI-8Y
PIXMA iP5200	Overseas models	PIG-5BK	CLI-8BK	CLI-8C	CLI-8M	CLI-8Y
		O	O	O	O	O
		BCI-9BK	BCI-7eBK	BCI-7eC	BCI-7eM	BCI-7eY
		X	X	X	X	X

O: Usable X: Not usable

#### Note:

The ink tanks BCI-9BK and BCI-7e series available in Japanese market are not compatible with the PIXMA iP5200 overseas models.

Be sure to use the appropriate ink tanks in servicing.

[To the top](#)

 <PIXMA iP5200 Specifications>

# PIXMA iP5200R REFERENCE MANUAL

This reference manual describes differences from the base model, PIXMA iP5200.

When referring to the PIXMA iP5200 Service Manual, Service Parts Number in it may be different from PIXMA iP5200 model. Please refer to the PIXUS iP5200R/PIXMA iP5200R Parts Catalog (QY8-9083-D0C).

QY8-13AJ-000



## TABLE OF CONTENTS

Page	<b>Part 1: MAINTENANCE</b>
3	1. MAINTENANCE
3	1.1 Adjustment, Periodic Maintenance, Periodic Replacement Parts, and Replacement Consumables by Service Engineer
3	2. LIST OF ERROR DISPLAY / LIST OF TROUBLESHOOTING
3	2.2 Service Call Errors (by LED Blinking in Orange and Green Alternately, or Lit in Orange)
3	2.4 Troubleshooting by Symptom
3	3. REPAIR
3	3.1 Notes on Service Part Replacement
4	3.2 Special Notes on Repair Servicing
5	3.4 Verification Items (3) Network setting information (NIC EEPROM information) Print
	<b>Part 3: APPENDIX</b>
8	1. BLOCK DIAGRAM
8	2. PIXMA iP5200R SPECIFICATION

## Part 1 MAINTENANCE

### 1. MAINTENANCE

#### 1.1 Adjustment, Periodic Maintenance, Periodic Replacement Parts, and Replacement Consumables by Service Engineer

##### (1) Adjustment (added to iP 5200)

Adjustment	Timing	Purpose	Tool	Approx. time
Network setting information print (NIC EEPROM information print)	NIC BOARD replacement	To confirm operations	None.	1 min.

### 2. LIST OF ERROR DISPLAY / INDICATION

#### 2.2 Service Call Errors (added to iP5200)

Cyclic blinking in orange (Alarm LED) and green (Power LED)	Error	Solution (Replacement of listed parts, which are likely to be faulty)
18 times	NIC BOARD error [6550]	NIC BOARD ASS'Y (QK1-1973-000)

#### 2.4 Troubleshooting by Symptom

	Symptom	Solution	Remarks
Faulty operation	Printing is not possible with wireless LAN.	1) Perform network setting information print. When printing is not possible. -> Replace the NIC BOARD. When printing is possible. -> Proceed to 2). 2) Perform printing with the wireless LAN I/F. When printing is not possible. -> Replace the NIC BOARD. (Wireless reception component failure on the NIC BOARD) When printing is possible. -> Re-confirm network setting (user's environment).	

### 3. REPAIR

#### 3.1 Notes on Service Part Replacement (and Disassembling/Reassembling)

Service part	Notes on replacement	Adjustment/settings	Operation check
NIC BOARD ASS'Y (QK1-1973-000)			- Network setting information print - Printing with wireless LAN I/F (After printing, EEPROM initialization of NIC BOARD is necessary.)

Note: If the NIC BOARD is replaced, user network setting information stored in the NIC BOARD is lost. Therefore, it is necessary to inform users that network setting should be performed again to enable the printer to be used under the user's environment.

<How to re-perform network setting>

- a. Performing Easy Install  
Application software, User's Guide, etc, are also re-installed.
- b. Custom Install  
The following items are selected as installation.
  - Printer driver
  - Network Setup
  - Canon IJ Network Tool

### 3.2 Special Notes on Repair Servicing

#### (4) User mode (added to iP5200)

Function	Procedures	Remarks
Network setting information print (NIC EEPROM information printing)	See <Standalone printer operation> below.	
Initialization of network setting information	See <Standalone printer operation> below.	Can also be performed from Canon IJ Network Tool

<Standalone printer operation>

- 1) Turn on the printer and the Reset button.
- 2) After the Power LED (green) blinks the specified number of times listed in the table below, release it. The operation starts.

LED blinking	Operation	Remarks
6 times	Network setting information printing	Set a sheet of A4/LTR-sized plain paper in the sheet feeder or cassette. (The Paper Feed switch controls the paper feeding location.)
10 times	Initialization of network setting information	
10 times or more	Unspecified	

For details on the network setting information printing and items cleared by initialization, see "3.4. Verification Items (3) Network setting information (NIC EEPROM information) print".

< WPA2 setting >

When setting WPA2 as an encryption method, be aware that there is a restriction as follows.

- When setting WPA2 from Network Tool, since WPA2 setting by entering SSID manually from the Configuration screen is impossible, perform WPA2 setting after selecting an access point by pressing the Search button .

WPA2 setting is also possible by re-installing the driver and from Network Configuration of a Web browser.

### 3.4 Verification Items

#### (3) Network setting information (NIC EEPROM information) print

<EEPROM information sample>

Canon iP5200R Network Congiguration Page

Printer : iP5200R  
Firmware Version : 1.02

Wireless LAN : Enabled  
Standard : IEEE 802.11g  
Destination : 1B  
MAC Address : xx-xx-xx-xx-xx-xx

Network Type : Infrastructure  
SSID : xxxxx  
Channel : 10  
Encription : OFF  
Authentication : Open System

Attached Information:

Link Status : Active  
Signal Strength : 63%  
Link Quality : 56%  
Transmission Rate : 36Mbps

TCP/IP  
Mode : Auto  
IP Address : xxx.xxx.x.xxx  
Subnet Mask : xxx.xxx.xxx.x  
Default Gateway : x.x.x.x

Wired LAN : Disable  
MAC Address : xx-xx-xx-xx-xx-xx  
Link Status : Inactive  
Transmission Rate :

TCP/IP  
Mode :  
IP Address :  
Subnet Mask :  
Default Gateway :

Printer Access Control  
MAC Address : OFF  
IP Address : OFF

Admin Password : OFF  
Device Status : Available

<EEPROM information contents>

Print items: List item for network setting print  
 Contents: Meaning of list items  
 Settable values: Settable values for users  
 Default values: Values at shipment from the plant  
 Items set to default values: Items re-set to the factory values (at shipment) by initialization

	Print items	Contents	Settable values	Default values	* Items set to default values
	Printer	Printer name	-	IP_5200R (Overseas)	
	Firmware Version	NIC firmware version	-	[Specific value. fixed]	
Wireless LAN setting information	Wireless LAN Standard	Wireless LAN enabled/disabled	Enabled/Disabled	Enabled	O
	Destination	Compliant wireless LAN standard	-	IEEE 802.11g[fixed]	
	MAC Address	Corresponding channel list	-	1B [fixed]	
	Network Type	MAC address for wireless LAN on NIC board	-	[NIC BOARD-specific value. Fixed]	
	SSID	Operation mode of wireless LAN	-	Infrastructure [fixed]	
	Channel	Set SSID When ANY is set, current SSID is printed in parentheses.	Optional (can be freely set.)	BJNPSETUP	O
	Encryption	Current channel When inactive, left blank	[Varies depending on connection status.]	[Blank]	O
	Authentication	Current encryption method	OFF/WEP/TKIP/AES	OFF	O
	Attached Information	Current authentication method	Auto /Open System /Shared Key/WPA-PSK/WPA2-PSK	Open System	O
	Link Status	Attached information regarding encryption and authentication	WEP setting: 64/128bit, ASCII/Hex, Key* * Key set by user is displayed. WPA-PSK setting: Character Password /64 Hex digits	[Blank]	O
	Signal Strength	Status of wireless LAN When wireless LAN is invalid, if nonexistent SSID is set, status becomes Inactive. Other than this case, status becomes Active.	-	Inactive	
	Link Quality	Signal strength: 0 - 100 % When inactive, 0 %	[Varies depending on communication environment.]	0 %	
	Transmission Rate	Communication quality: 0 - 100 % When inactive, 0 %	[Varies depending on communication environment.]	0 %	
TCP/IP (wireless)	Mode	Current wireless LAN speed: 1/2/5.5/6/9/11/12/18/24/36/48 /56 Mbps When inactive, left blank	[Varies depending on the communicating devices.]	[Blank]	
	IP Address	IP address setting method When disabled, left blank	Auto/Manual	Auto	O
	Subnet Mask	Current IP address When disabled, left blank	0.0.0.0 - 255.255.255.255	192.168.1.123	O
	Default Gateway	Current Subnet mask When disabled, left blank	0.0.0.0 - 255.255.255.255	255.255.255.0	O
		Current default Gateway When disabled, left blank	0.0.0.0 - 255.255.255.255	0.0.0.0	O

Wired LAN setting information	Wired LAN	Wired LAN enabled/disabled	Enabled/Disabled	Enable	
	MAC Address	MAC address for wired LAN on NIC board	-	[NIC BOARD-specific value. Fixed]	
	Link Status	Status of wired LAN When wired LAN is invalid, status becomes Inactive. Other than this case, status becomes Active.	-	Inactive	
	Transmission Rate	Current wireless LAN speed 10/100 Mbps When inactive, left blank	-	[Blank]	
TCP/IP (wired)	Mode	IP address setting method When disabled, left blank	Auto/Manual	Auto	O
	IP Address	Current IP address When disabled, left blank	0.0.0.0 - 255.255.255.255	192.168.2.123	O
	Subnet Mask	Current Subnet mask When disabled, left blank	0.0.0.0 - 255.255.255.255	255.255.255.0	O
	Default Gateway	Current default Gateway When disabled, left blank	0.0.0.0 - 255.255.255.255	0.0.0.0	O
Security	MAC Address	MAC address filtering setting	ON/OFF	OFF	O
	IP Address	IP address filtering setting	ON/OFF	OFF	O
Other	Admin Password	Admin password setting	ON/OFF	OFF	O
	Device Status	Printing of device status When error occurs, error code is displayed. Other than this case, Available is displayed.		Available	O

## Part 3 APPENDIX

### 1. BLOCK DIAGRAM

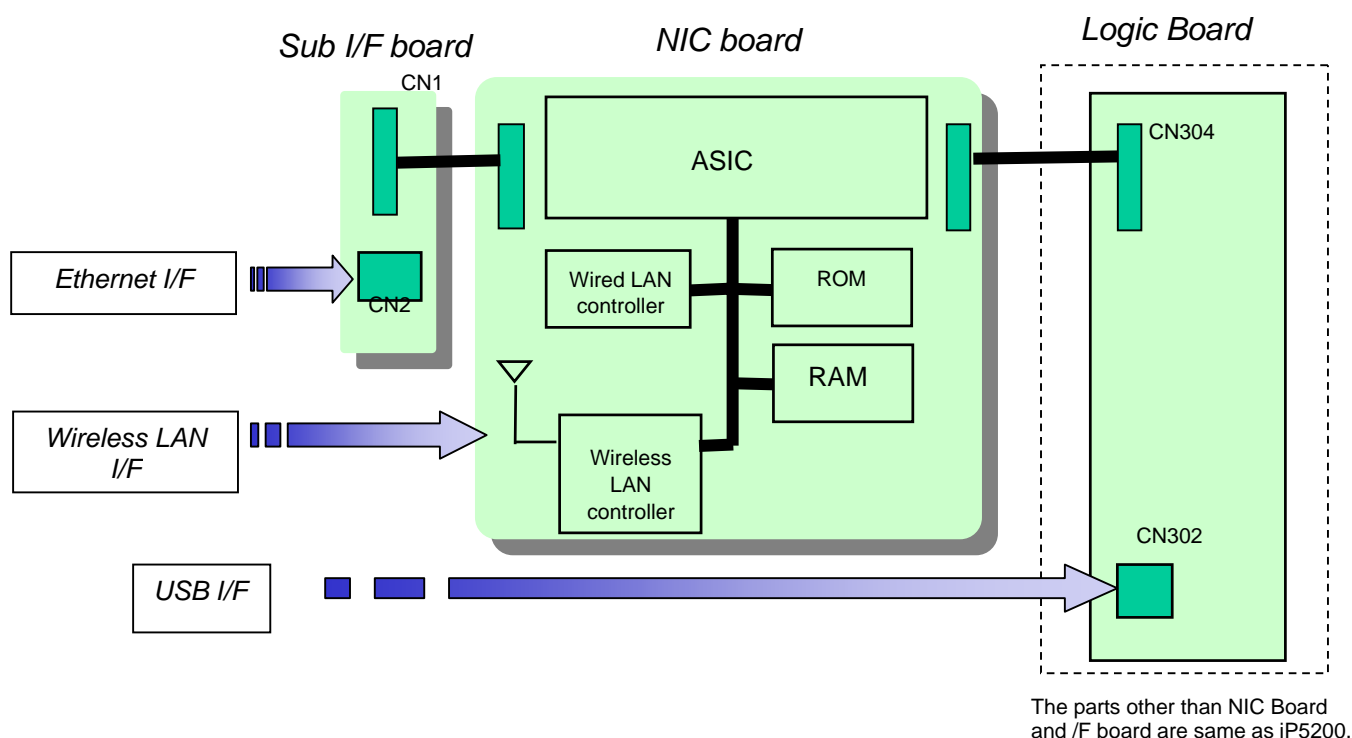

### 2. PIXMA iP5200R SPECIFICATION (differences from iP5200)

#### < Specifications >

Interface	Wireless LAN, wired LAN interface port (RJ-45) x1 USB 2.0 Hi-Speed x1
Printing speed* (Wireless printing)	Color (4x6) PP-101 / Standard / Borderless 56 sec.
Power consumption	Standby: 3 W Off: 0.4 W During printing: Approx. 19 W
Weight	7.5 Kg
Related standards (Proposed) (Printer, Adapter)	Electromagnetic radiance: VCCI, FCC, IC, CE Mark, C-Tick Electrical safety: Electrical Appliance and Material Safety Law (DENAN), UL, C-UL, CB Report, CE Mark, GS, FT, SPRING Wireless: FCC, IC, CE Mark (R&TTE), ACA, RSM, Telecommunication Act (SPL) Environmental regulations: RoHS (EU), WEEE (EU), Energy Star, Eco Mark, Law on Promoting Green Purchasing, Chemical Substances Control Law, Battery Recycle Law, Container and Packaging Law, Blue Angel

\* Text printing speed and printing speed when connected with the USB cable are the same as the PIXMA iP5200.

\* Printing speed when connected with wireless LAN varies depending on communication speed and environmental conditions.

## < Network specifications >

Communication protocol	TCP / IP, UDP
Wired LAN	
Compliant standard	IEEE802.3u (100BASE-TX) / IEEE802.3 (10BASE-T)
Transmission speed	10M / 100Mbps (automatic switching)
Wireless LAN	
Compliant standard	IEEE802.11g / IEEE802.11b, ARIB STD-T66
Used frequency band	2.412GHz-2.462GHz
Channel	1-11
Transmission system	OFDM / DS-SS system
Transmission speed	54 / 48 / 36 / 24 / 18 / 12 / 9 / 6Mbps (IEEE802.11g, automatic changing) 11 / 5.5 / 2 / 1Mbps (IEEE802.11b, automatic switching)
Communication distance	50 m *varies depending on communication speed and environmental conditions
Security	WEP (64/128 bit), WPA-PSK (TKIP/AES), WPA2-PSK (TKIP/AES)
Other	Wi-Fi logo acquired
Acquired standard	TELEC, FCC, IC, ETSI, iDA